

Page Two

At the Village



By Dottie Johnson

What a wonderful group of celebrants arrived at the historic Cauble House...

Good memories, food, fellowship, music combine at celebration

It's not over 'til it's over. From Conroe came Ann and Jim Laird, who only recently delivered to the Village the first copies of their monumental new Tyler County Cemetery Book...

What a wonderful group of celebrants arrived at the historic Cauble House last Monday evening to join in a salute to our country's 218th birthday...

Also in attendance was Mary Wilson Felton, who came down from Lindale with her husband Charles to join in the festivities with J. R. Wilkison, still a Chester resident...

Readers Write

Sewage plant system opposed

Dear Editor: Like most residents of the Woodville area, we have known for some time of the need and plan to increase sewage treatment facilities in Woodville...

Weatherford completes DPS Training Academy

AUSTIN — The Texas Department of Public Safety Training Academy recently graduated 123 trooper cadets from its first recruit school in four years...

Church to honor pastor, wife

WOODVILLE — Third anniversary services honoring the Rev. and Mrs. R.L. Session will be held Sunday, July 10, at the Pilgrim Rest Missionary Baptist Church...

Outreach services planned

WOODVILLE — The Mission Outreach Services will be held July 13-16 beginning at 7 p.m. nightly at the Warren Chapel Baptist Church...

CPR course offered July 20

WHITE TAIL RIDGE — A Basic Life Support (CPR) course is being offered to residents of Woodville, July 20th, at Tyler County Hospital...

Art league demonstration set

JASPER — Betty Robbins will demonstrate portrait painting by shapes during a meeting of the Pineywoods Art League scheduled for 6:30 p.m. Monday, July 11, at the United Methodist Church in Jasper...

Gulf retirees meet Friday

SPURGER — The Tyler County Gulf Retirees Club, which normally meets the second Friday of each month in Spurger, will meet at 5 p.m. Friday, July 8 at the Catholic Club in Jasper...

Cemetery association to meet

COLMESNEIL — The Bethany Cemetery Association will meet at 7 p.m. Saturday, July 9, at the Bethany Baptist Church in Colmesneil...

Tri-County board to meet

NEWTON — There will be an open meeting of Tri-County Community Action, Inc., on July 18 at the Newton Civic Center, located on Loop 305, Newton...

The Tyler County Booster. Serving the people of Tyler County since 1930. (409) 283-2516. 205 W. Hill St. P.O. Box 339 Woodville, Texas 75772.

Tyler County Aging Center Menus. WOODVILLE — The following is the lunch menu for the Tyler County Aging Services, Inc., 201 Willow St., Woodville, for July 6-16...



July wedding planned

Mr. and Mrs. Don A. Clotiaux Jr. of Corpus Christi have announced the engagement and approaching marriage of their daughter, Shannon Clotiaux, of Huntsville, to Keith McQueen, son of Mr. and Mrs. Talmadge McQueen of Fairfield...



Anniversary celebrated

Burl and Juanita Chance of Long Beach, Calif., celebrated their 25th wedding anniversary on June 21. Both graduated from Warren High School in May 1969 and were married on June 21, 1969...

Engagement announced

Mr. and Mrs. James R. Overstreet of Hillister have announced the engagement and approaching marriage of their daughter, Shannon Kimberly Overstreet, to Richard Burton "Kooter" Shaw, son of Mr. and Mrs. Richard Shaw of Doucette...

Berryman attends seminar

SAN ANGELO — Attending the Texas Farm Bureau's 32nd annual Citizenship Seminar here June 13-17, was Noelle Berryman, a Woodville High School senior...

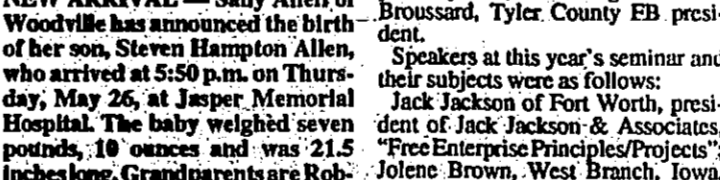

Noelle Berryman

Watts, Smoczyk united June 18 in Livingston

LIVINGSTON — Piper Kerri Watts and Rodney Edward Smoczyk were united in marriage during a double-wedding ceremony held at 7 p.m. June 18 at the First United Methodist Church in Livingston...

The bride is the daughter of Mr. and Mrs. Willis Terry Watts of Livingston and the groom is the son of Mr. and Mrs. Robert Smoczyk of Houston...

The bride chose for her wedding a formal gown designed by Lilli of white satin combined with hand-beaded Schifflin lace. A fitted Basque bodice revealed heavily hand-beaded and sequined appliques of the Schifflin lace...



Mrs. Rodney Edward Smoczyk

Tyson completes residency

DALLAS — Todd B. Tyson, M.D. has completed a four-year residency program in anesthesiology at Parkland Hospital in Dallas...

Daughter arrives on June 21

WOODVILLE — Anna Fussell has announced the birth of her daughter, Addison Lynn, who arrived June 21 at the Tyler County Hospital in Woodville...

Hear more with less!!!

Hearing aids from Bellone have helped more than 1 million people keep their hearing problems a secret. Take the Bellone Ode canal hearing aid, for example. It's so small it fits completely in the ear canal. No wires. No tubes. No cords. So virtually nothing shows...

Professional Hairstyling. Shirley's Hair Salon. 309 N. Wheeler - Colmesneil, Tx. OPEN 9-5 p.m. Tuesday-Wednesday 9-8 p.m. Thursday 9-5 p.m. Friday 8:30-2 p.m. Saturday. Appointments & Drop-ins Welcome. 837-5131 Shirley Grimes - Owner/Operator (13 years experience in Dallas area)

Men's - Women's - Children's. Nike. Reebok. 20% - 40% off Selected Styles. GOOD SELECTION! TODDLERS' & CHILDREN'S. Short Sets & Summer Sportswear. 30% off. GIRLS' DRESSES. 50% off. School Starts Early. SHOP NOW FOR BEST SELECTIONS. Quality Clothing & Shoes. FOR 5 YEARS.

Summer Clearance!! POSTUREPEDIC MANN FURNITURE beginning at \$87.50 each piece

WANT TO BUY PINE & HARDWOOD Kirby Forest Industries Louisiana-Pacific

THE MUFFLER SHOP UNDER NEW OWNERSHIP Repairs Cars & Trucks

Introducing the most beautiful liquid MAKEUP under the sun. MERLE NORMAN COSMETIC STUDIOS

Tyler County's Business Of The Week THE MUFFLER SHOP For all your Muffler & Radiator Repairs

Dairy Queen DAIRY QUEEN Plate Lunches \$4.95 Offered Daily at S. Magnolia Dairy Queen

FRED GROCERY KEITH HATTON WATERMELONS! Red & Yellow 12-Pack COKE & DR. PEPPER

MUFFLER SHOP PH-2835502 Cars & Trucks Domestic & Foreign Custom Dual Exhaust

T&M JEWELRY REPAIR GRAND OPENING JULY 14 OPENING FOR BUSINESS SATURDAY, JULY 9

'94 FORD CROWN VICTORIA \$17,995 KNAPP FORD V8 Automatic Clearcoat Paint

LAWN-BOY Rated "Best Buy" Two Years In A Row. TIMBERMAN'S SUPPLY

DOGWOOD TRAILS MANOR Helen Hotchkin, new Activities Director at Dogwood Trails is also new to the Tyler County area

1. GARAGE SALES 2. NUTRITION/WEIGHT LOSS 3. YARD CARE 4C. CONSTRUCTION/REMODELING

4D. DOZER WORK 5. ANNOUNCEMENTS 6. SECURITY FINANCE CORP. Loans from \$100 to \$396

Job Opportunity DIESEL MECHANIC/SHOP FOREMAN Pride Peppel Co., a fast growing crude oil trucking company

9A JOBS AVAILABLE Keller Aluminum Products of Texas has openings on the First Shift: Five 8-hr shifts

The Tyler County Booster Classified Ads Get Results Serving the people of Tyler County since 1930

MANN FURNITURE & APPLIANCE Friedrich Air Conditioners! Whirlpool Air Conditioners

9B. MEDICAL JOBS AVAILABLE WANTED LVN's and CNA's PERM Apply in person

10A. HOMES FOR SALE 3 Br. 2 Ba Home For Sale By Owner CHA, very nice

USED VEHICLE CLEARANCE SALE 1991 Lincoln Mark VII 2 Dr. 1992 Ford Tempo GL 4 Dr.

64 \$2.95 FOR 295 PORTRAITS ONLY 1-8x10, 2-5x7's, 10 Wallets, 24-Billfolds

Call Diane 1-800-967-6271 10B. MOBILE HOMES FOR SALE Largest volume dealer in East Texas...

CALL FOR AN APPOINTMENT TODAY Office 283-3110 Home 283-8110 Andrea Ayers 7 Miles South of Woodville on Hwy 69.

CHARLES RAWSON CO. REAL ESTATE Charmaine Waterfront Brick 3-2-2 double carport, bathhouse, T-pier, workshop, on 2.4 landscaped lots... \$250,000

Thinking of Selling? List With Us!

H.E. 'Bud' Jones Real Estate 106 E. Bluff 283-5000 Woodville HOMES-RANCHES-ACREAGE-FHA-VA

CHARMING 90 year old home - 3 Br, 3 Ba, 3400 sq. ft. BRICK HOME... BRICK HOME - 3 Br, 2 Ba, 2100 sq. ft. BRICK HOME - 3 Br, 2 Ba, 2100 sq. ft.

BOOSTER CLASSIFIEDS Get Results

PROFESSIONAL REALTY "25 YEARS In The Business" Billy Frank & Charlotte Eaves 283-7889 (Office) 283-2747 (Home)

1.3 - 1 1/2 Frame, CHA, on 4.7... 2. 4 Br, 1 Ba - Small lake... 3. Waterfront Retreat - Small camp...

Jackie Brown 409-837-2973 Real Estate US 69, Colmesneil James and Jackie Brown

Frog Pond Lake, 1.65 acres... Lake Amanda, Mobile Home... Lake Amanda, Wooded Lot...

TRI-COUNTY Thelma Cain Broker/Owner

ELGANT ESTATE HOME - Just walk into this graceful formal 3 Br, 2 Ba... 190 WEST - Just walk in, 3 Br, 2 Ba, pool size hot tub...

409-283-3216 FAX 409-283-3216 283-3216

East Texas Land Co. SALES - MANAGEMENT - TIMBER SAME LOCATION 23 YEARS

325 ACRES pasture, some woods along creeks... 30 ACRES with remodeled Frame Home - US 190 frontage...

10B. MOBILE HOMES FOR SALE \$1,745 Down \$329.12 Monthly Beautiful new 3 Br, 2 Ba doublewide with...

10C. ACREAGE Mini Slt - 2 lots on Charlemagne across from...

11A. HOMES FOR RENT Home For Rent Two bedroom, one bath...

11B. MOBILE HOMES FOR RENT FOR RENT: One bedroom trailer in...

11C. APARTMENTS FOR RENT: Two bedrooms, one bath...

11D. COMMERCIAL For Sale - Commercial building for office...

210 South Magnolia Blvd. 409/283-5252

12B. APPLIANCES Dryers and washers, \$85 to \$150, six month warranty...

12H. FURNITURE Brand new, queen size, complete 928 firm orthopedic mattress set...

12L. HOUSEHOLD ITEMS Sleight Big Size Open arm for cutlery, sewing machine, needle, darning, applique, monogram...

12Q. WANTED TO BUY Attention Homebuyers - I buy plus or minus 10% below market value...

10C. ACREAGE Delinquent TAX SALE LAKE LIVINGSTON - LAKEFRONT COMMUNITY

10C. ACREAGE Delinquent TAX SALE LAKE LIVINGSTON - LAKEFRONT COMMUNITY

NOTICE OF APPLICATION TO RECONCILE FUEL COSTS Under the terms of the Commission's Final Order in Docket No. 11282...

10C. ACREAGE Delinquent TAX SALE LAKE LIVINGSTON - LAKEFRONT COMMUNITY

10C. ACREAGE Delinquent TAX SALE LAKE LIVINGSTON - LAKEFRONT COMMUNITY

10C. ACREAGE Delinquent TAX SALE LAKE LIVINGSTON - LAKEFRONT COMMUNITY

10C. ACREAGE Delinquent TAX SALE LAKE LIVINGSTON - LAKEFRONT COMMUNITY

10C. ACREAGE Delinquent TAX SALE LAKE LIVINGSTON - LAKEFRONT COMMUNITY

10C. ACREAGE Delinquent TAX SALE LAKE LIVINGSTON - LAKEFRONT COMMUNITY

10C. ACREAGE Delinquent TAX SALE LAKE LIVINGSTON - LAKEFRONT COMMUNITY

10C. ACREAGE Delinquent TAX SALE LAKE LIVINGSTON - LAKEFRONT COMMUNITY

10C. ACREAGE Delinquent TAX SALE LAKE LIVINGSTON - LAKEFRONT COMMUNITY

10C. ACREAGE Delinquent TAX SALE LAKE LIVINGSTON - LAKEFRONT COMMUNITY

10C. ACREAGE Delinquent TAX SALE LAKE LIVINGSTON - LAKEFRONT COMMUNITY

10C. ACREAGE Delinquent TAX SALE LAKE LIVINGSTON - LAKEFRONT COMMUNITY

10C. ACREAGE Delinquent TAX SALE LAKE LIVINGSTON - LAKEFRONT COMMUNITY

129. WANTED TO BUY Land Wanted: Will buy your land under power and hardwood timber...

14. FARM EQUIPMENT Farm Equipment for sale: 25 rounds used tractor, 60 HP and below...

16A. AUTOMOBILES 1987 BUICK CENTURY: four cylinder power, automatic transmission...

16B. TRUCKS 1985 Isuzu pickup, 4 wheel drive, air and power, 44,000 actual miles...

16A. AUTOMOBILES Cash for your car or truck - Preferred Autos, 283-1866, Call 283-3200...

19. LEGAL NOTICES ADVERTISEMENT AND INVITATION FOR BIDS Colmesneil L.S.D. will receive bids for the date of the opening...

19. LEGAL NOTICES ADVERTISEMENT AND INVITATION FOR BIDS Colmesneil L.S.D. will receive bids for the date of the opening...

19. LEGAL NOTICES ADVERTISEMENT AND INVITATION FOR BIDS Colmesneil L.S.D. will receive bids for the date of the opening...

19. LEGAL NOTICES ADVERTISEMENT AND INVITATION FOR BIDS Colmesneil L.S.D. will receive bids for the date of the opening...

19. LEGAL NOTICES ADVERTISEMENT AND INVITATION FOR BIDS Colmesneil L.S.D. will receive bids for the date of the opening...

19. LEGAL NOTICES ADVERTISEMENT AND INVITATION FOR BIDS Colmesneil L.S.D. will receive bids for the date of the opening...

19. LEGAL NOTICES ADVERTISEMENT AND INVITATION FOR BIDS Colmesneil L.S.D. will receive bids for the date of the opening...

19. LEGAL NOTICES ADVERTISEMENT AND INVITATION FOR BIDS Colmesneil L.S.D. will receive bids for the date of the opening...

19. LEGAL NOTICES ADVERTISEMENT AND INVITATION FOR BIDS Colmesneil L.S.D. will receive bids for the date of the opening...

19. LEGAL NOTICES ADVERTISEMENT AND INVITATION FOR BIDS Colmesneil L.S.D. will receive bids for the date of the opening...

19. LEGAL NOTICES ADVERTISEMENT AND INVITATION FOR BIDS Colmesneil L.S.D. will receive bids for the date of the opening...

19. LEGAL NOTICES ADVERTISEMENT AND INVITATION FOR BIDS Colmesneil L.S.D. will receive bids for the date of the opening...

19. LEGAL NOTICES ADVERTISEMENT AND INVITATION FOR BIDS Colmesneil L.S.D. will receive bids for the date of the opening...

19. LEGAL NOTICES ADVERTISEMENT AND INVITATION FOR BIDS Colmesneil L.S.D. will receive bids for the date of the opening...

19. LEGAL NOTICES ADVERTISEMENT AND INVITATION FOR BIDS Colmesneil L.S.D. will receive bids for the date of the opening...

Read the Classifieds for great bargains!

SUMMER SALE \$298

BASSETT Side-By-Side \$688

CHEST 4 Drawers \$38

RECLINERS Starting At \$149

Sylvania 20" Color TV \$288

CORSICANA CRAZY QUILT Mattress Sale... YOUR CHOICE

Day Beds 1 Mattress & Frame White & Brass \$199

Piney Woods Warehouse Furniture & Appliances FREE DELIVERY FINANCING AVAILABLE MAJOR CREDIT CARDS ACCEPTED

Business Bulletin Board

Ramsey's Mini Warehouse Self Storage-NOW LEASING 1 Mile on Jasper Hwy 190 East Woodville, Texas 283-3481 or 283-5069

Britt Construction "You Name It - We Do It" Woodville, Texas (409)283-3225

DISCOUNT PEST CONTROL Ken DeRouen Rt. 2 Box 788 Warren, Tx (409)547-3362

CHAT AND CHEW WAGON Specializing In Hot Tamales Manufactured By The Tamale Co. Owner Christine Campbell P.O. Box 2254 Woodville, Texas 283-6810

Sanderson Home Improvements Ed Sanderson 283-5430

WOODY'S SIDING MOBILE HOME ROOF-OVERS WINDOWS • DOORS • ROOM ADDITIONS (409) 429-5941

Anna's Tire, Oil & Lube Shop We also do tune-ups Hwy. 69, Warren Open 6 days a week Monday-Saturday, 8a.m.-5p.m. 547-2555

CC's DEFENSIVE DRIVING SCHOOL/U.S.A. \$29 (includes lunch) Call 1-800-272-0855 to register (state approval through Texas Education Agency)

Greg Kirkpatrick Dirt Work • Dozer Work Asphaltting Field Dirt Iron Ore Rock Top Soil (409)283-8555

Increase your profits. Hang your business card on Tyler County's Business Bulletin Board. Call 283-2516 today!

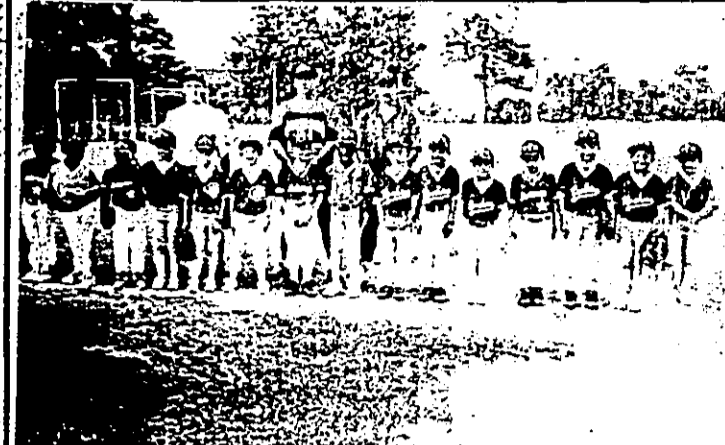

T-Ball National All-Stars
Cody Cox, Jared Wallace, Zack Landi, Jay Reese, Blake Backner, Craig Thompson, Drew Brown, Eliph Brown, Casey Beck, Michael Toucha, Courtney Williams, Shawn Lamson, Justin Benton, Alex Rigby, Steven Dodd, and Joshua Cruse



T-Ball Sweethearts
Doris McCarrich, Kelli McKee, Corby Weyler, Heather Handy, Mengian Tillery, Jania Thompson, Carrie Spivey and Hillary Wade



T-Ball American All-Stars
Justin Cherry, Shawn McQueen, Wesley Walker, Dewey Rivers, Cullen Williams, Jake Hickman, Jordan O'Neal, Trevor Rainey, Jarrod Johnson, Chad Willmon, Gary Bullock, Logan Alec, Micha Robinson, Manning Robinson and Brandon Ellis

TYLER COUNTY T-BALL LITTLE LEAGUE



Astros
Casey Beck, Steven Dodd, Nicholas Fullington, Rafe Fullington, William Hardy Jr., Brady Kirkland, Adrin Mack, Cory Maxwell, Cody Pace, Alex Bigsby, Cody Toucha and Michael Toucha. Manager: Dennis Atwell; Team Mom: Tammy Maxwell and Mary Maxwell

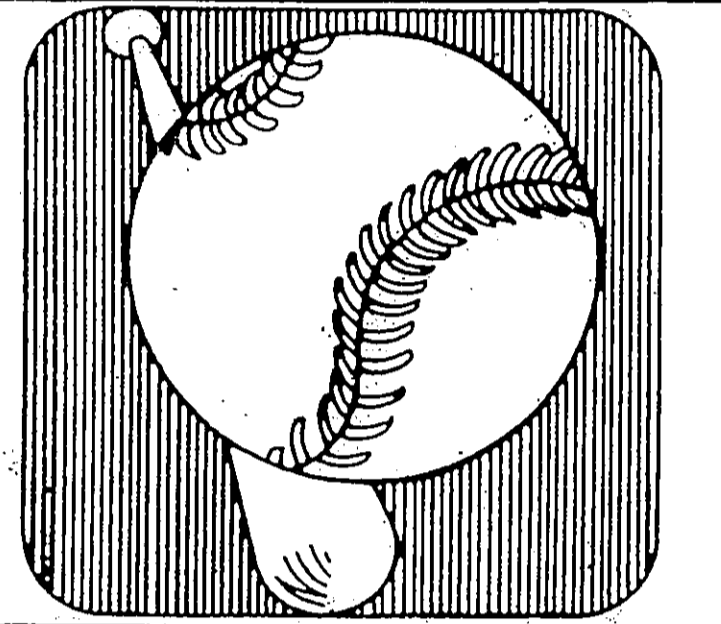

Blue Jays
Justin Kirkpatrick, Bryan Barlow, Bryan Hughes, Jesse James, Chad Willman, Dusty Procter, Daryl Parish, Aaron Hicks, Joshua Mitchell, Jonathan Beauchamp, Marshal Valley, Robert Zanotti, Donnie Releford, Cody Buschmeier and Aaron Sanford. Manager: John M. Killian; Coaches: Jimmy Willman and Steven Parker.

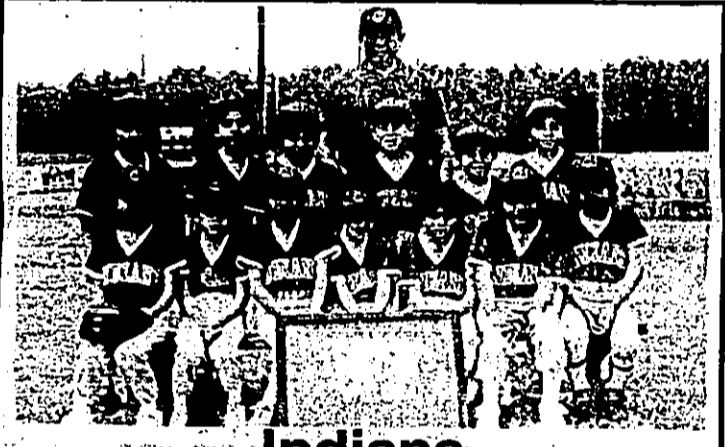

Indians
Micah Robinson, Manning Robinson, Courtney Battise, J.R. Bullock, Cassie Bantze, Jason Williams, Mitchell Alec, Kirk Sylvestine, Janai Thompson, Keria Sylvestine, Stacey Langley, Gregory Battise, Ross Abbey, III and Logan Alec. Manager: William Sylvestine; Coach: Floyd Poncho.

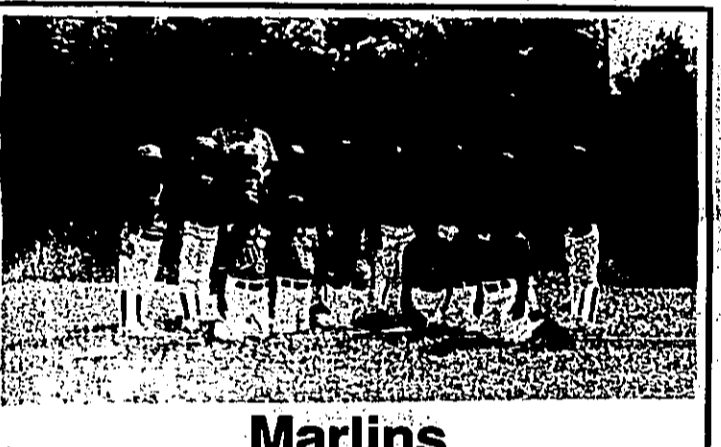

Marlins
Kael Little, Krystalle Mayer, Justin Jefferson, Justin Gage, Cliff Renick, Levi Foxworth, Brandon Ellis, Travis Hanton, Marcus Wallace, Derek Wise, Brandon Sims, Ricky Joe Wood, Matt Sweeney and Joseph McCullum. Sponsor: Warren Baseball; Manager: Susan Wise; Coach: Linda McCullum; Sweetheart: Kelli McKee; Team Mom: Darlene Sims.



Mets
Chase Nalley, Corday Williams, Matthew Williford, Matthew Dahill, Ely Broom, David McCollister, Christopher Haven, Broderick Murchison, Silane Todd, James Ponder, David Ponder, Robert Gilder, David Summers and Drew Broom. Manager: Russ Nalley.

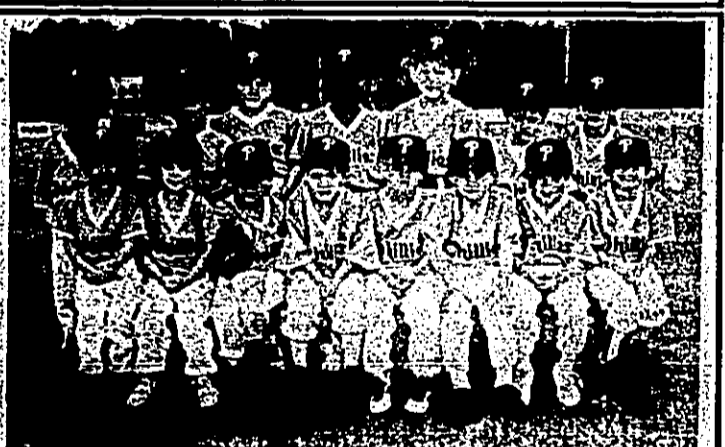

Phillies
Brad Belschner, Joshua Cruse, Jake Lutz, Tyler Lutz, Brodrick Mitchell, Christopher Poindexter, Samantha Poindexter, Cody Powers, Cody Powers, Zack Rigby, Christopher Smith, Daniel Spivey, Kelli Stephens and Trey Turner. Manager: Brent Belschner; Coach: Stuart Lutz.



Pirates
Sam Carson, Rusty Mott, Shawna Jordan, Rachel Hutto, Ben Mott, Jason Griffith, Heather Golden, Johnny Whitaker, Bill Osborn, Justin Benton, Charles Jordan and Phillip Whitaker. Manager: Allen Benton; Coach: Billie Jordan

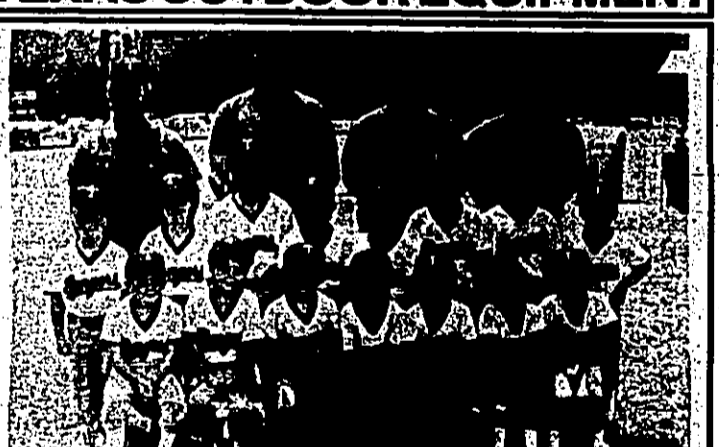

Rangers
Jason McKnight, Dewey Rivers, Sean McQueen, Joshua James Marceaux, Justin Cherry, Dustin Woodrome, Clint Tolar, Zachary Founds, Wesley Walker, Cody Welch, Kayla Cook, Sami Hubert, Amber Walker, Kandee Hooks and Megan Standley. Manager: Ray McKnight.



Reds
Micah Cruse, Tanner Spivey, Steve Brown, Dallas Gulliford, Sean Lewis, Drew Pender, Brandon Rainey, Hillard Ward, Keatrina Callagher, Jennifer Russell, Clay Thompson, Aaron Bryant, Joshua Godfrey, John Seneker and Daniel Ellis. Sponsor: East Texas Insurance; Manager: Ronald Powers; Coach: Kenneth Adewuyi



Rockies
Cody Cox, Corben Thornell, Jay Reese, Zach Landy, Jarrod Johnson, Jared Tipton, Richard Sammill, Todd East, Jared Wallace, Blake Backner, Cates Kelly, Darrell Johnson and Clinton Ard. Sponsor: Spindletop Street Rods; Manager: Charlie Cox; Coaches: Clint Hutton, Drew Thornell, Ronnie Reese and Paul Landy; Sweetheart: Corby Weyler; Team Mom: Karal Cox.



Tigers
Latreon Pickett, Cullen Williams, Matthew Cruse, Baylor Butler, Zack Loring, Jake Hickman, Justin Smith, Trevor Rainey, Brent Blanchette, Malcolm Lewis, Jordan O'Neal, Brent Elrod, Jarrod Johnson and Jarrod Lomte. Manager: Clint O'Neal; Coach: C. S. O'Neal

SINCLAIR CHILDREN'S CENTER

E&L LUMBER COMPANY

E&L LUMBER COMPANY

TYLER COUNTY PITCHBALL LITTLE LEAGUE



Pitchball American Allstars
Dallas Hatton, Levi Townsend, Jake Cotten, Garrett Ribb, Travis Copeland, Josh Rogers, Caleb Phipps, Robin Morris, Brandon Pate, Brock Hanks, Casey Housh, Martin Spurlock, Brad Stephens, Chris Tribble, Corey Haven.



Pitchball Sweethearts
Christy Ogden, Melissa Chaney, Nikki Ray, Rachel Beauchamp and Janay Taylor

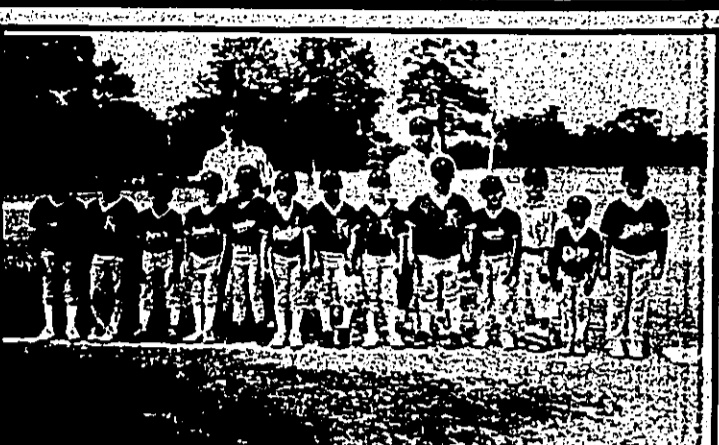

Pitchball National All-Stars
Jim Bass, Ryan O'Neal, Bryan Carruthers, Elish Gray, Jacob Williford, Brandon Temple, Blake Brown, Jared Carter, Joey Cady, Jake Witherford, Michael Hart, Jason Allen, Michael Hadnot.



Astros
Ryan O'Neal, Bryan Carruthers, Jacob Williford, Brandon Temple, Jared Carter, Jake Ruberford, Michael Hart, Bennett Champagne, Micah Hadnot, Brad Elrod, Jonathan Martin and Mathew Birdwell. Manager: Greg Temple; Coach: Randy Carter.



Cardinals
Kyle Harrison, Jon Reese, Blake Brown, Cody Hanks, Chad Hanks, William Shutter, Elijah Gray, Joe Patrick, Michael Gryder, Joey Cady, Jim Bass and Jason Allen. Sponsor: Gardner Oil Co.; Manager: Robert Gray; Coaches: Villa Spurlock and Kirk Brown.



Dodgers
Dallas Hatton, Nicholas Wallace, Stephen Dvorman, Christopher Little, Chris Hooper, John Michael Lee, Robie Morris, Aaron Dickey, Rachel Beauchamp, Jarrett Monzingo, Joey Brown and Danny Rose. Sponsor: B & J Amusements; Manager: Jack Morris; Coaches: Kevin Dickey, Bobby Risch and Keith Hatton; Sweetheart: Rachel Beauchamp; Team Mom: Melanie Hadnot.



Orioles
Devan Blythe, Brandon Pate, Tommy Richardson, Casey Hough, Corey Havens, Chris Gonzales, William Dahill, Christopher Tribble, James Morgan, Danny Meshe, Jared Taylor, Cliff Russell, Joshua Rogers and Aaron Dickey.



K.C. Royals
Jake Cotton, Levi Townsend, Brad Stevens, Brock Hanks, Calib Phipps, Martin Spurlock, Travis Coplen, Michael Adams, Jimmy Willman, Michael Lane, Brad Evans and Reggie Wise. Manager: Larry Coplen; Coaches: Brian Bell and Charles Spurlock.

PREFERRED AUTO

GARDNER OIL COMPANY

CITIZENS BANK FIDIC

"Little League Ball... It's The Best!"

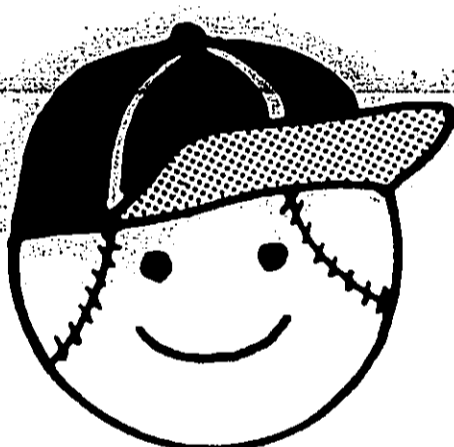

The Tyler County
Booster
Where You'll
find all your
Tyler County
sports news!

Jacques Blanchette: 'The Voice of Tyler County Baseball'

On almost any baseball night at Hennigan Baseball-Park-in-Tyler County, the fans are continually amused by the spontaneous chatter of official Baseball Park announcer Jacques Blanchette.

Not only does he sound like a real pro, but officials from other baseball leagues have tried to take him home with them to help put on their own baseball tournaments.

"Win or lose, said one fan, you feel like you've been given something when you leave the game. Baseball's fun anyway, but Jacques makes it special!"

Before he goes anywhere to any other town," said County Sheriff Gary Hennigan, who is also the League President. "They'll have to get me to say OK...and," he added, "don't hold your breath."

Jacques Blanchette

TYLER COUNTY MINOR LITTLE LEAGUE



Braves

Ryan Foxworth, Kerry Harrison, Philip Graham, Jim Ed Mann, Chris Douglas, Mathew Brisico, Daniel Cady, Jake Snider, Brandon Snider, Nathan Bryan and Hunter Mann. Sponsor: Davis Grocery; Manager: Jeff Mann; Coach: Charles Ross.
DAVIS GROCERY-WARREN



Minor: 9-Year-Old Allstars

Chad Beck, Shawn Bible, Heber Odom, Jerred Buckner, Daniel Cady, Joshua Falcon, Jason Ferguson, Nicholas Foret, Clay Hensarling, Quincy Mack, Dereck Marshall, Twan Mitchell, Travis Morrell, Jacob Terrell and Adam Grisson.
TYLER COUNTY BOOSTER



Cardinals

Josh Worthy, Brandon Worthy, Brandon Simmons, James Gallagher, Billy Milner, Derek Marshall, Robert Harry, Keith Hughes, Jason Ferguson, Donald Thompson and Kaleb Hughes. Sponsor: Mack Truck Sales; Jasper; Manager: Doug Harry; Coach: Chester Marshall.
TYLER COUNTY BOOSTER



Dodgers

Joshua Keith, Danny Rose, Toby Earl, Justin Hatton, Cody Byrd, Eric Foxworth, Melissa Sumrall, Joey Mayer, Cody Crawford, Matt Crawford and John Shearer. Sponsor: Wildwood Resort; Manager: Rick Earl; Sweetheart: Krystle Cox; Team Mom: Diane Rose.
WILDWOOD RESORT

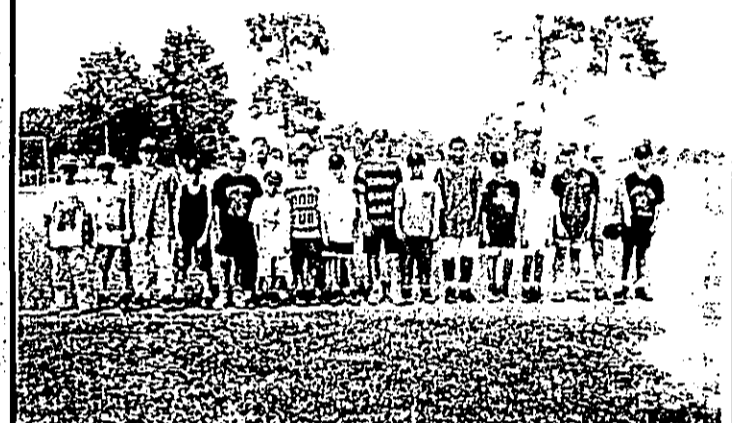

Minor-10-Year-Old Allstars

Nathan Nichole: Drew Tucker, Brandon Kinard, Jed Townsend, Brian Martin, Derek Hardin, Billy Milner, Brian Chapman, Trent Obama, Caleb Black, Noel Hood, Ross Johnston, Brandon Snider and Patrick Hadnot.
A-Z AUTO PARTS

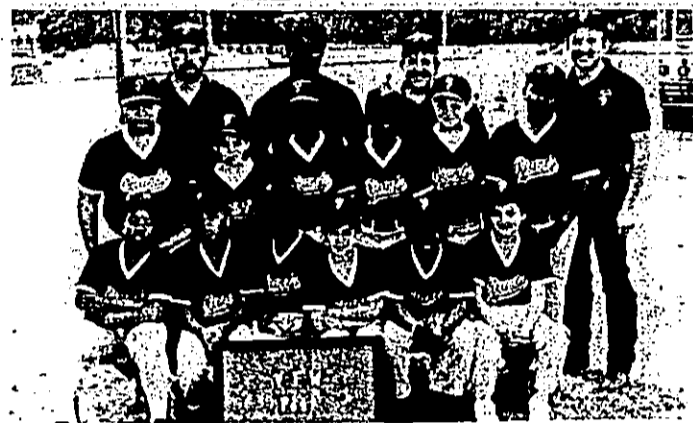

Giants

Shawn Bible, Twan Mitchell, Germany Johnson, Zachary Lyn Moya, Casey Lynn Clow, Trent Obama, Rastick Hadnot, Tony Wooten, Ed Barlow, Mackenzie Lockhart, Cody Rutherford and Ethan Bahise. Manager: Keith L. Reese; Coach: Sam Bible.
A-Z AUTO PARTS



Mariners

Garett Blake Robert Blaylock, Brian Casey Champagne, Joshua Lee Falcon, Heber Odom, Mark E. Rainwater, Brandon Tribble, Barry Blaine Whisenant, Chris Williams, James Deyon Williams and Buddy O'Hara. Manager: Lindsey Whisenant; Coach: Tony Felson.
LINDSEY WHISENHANT



Mets

T. J. Lingle, Brandon Mitchell, Darrell Morris, Mark Philpott, Dustin Barlow, Clint Dean, Jared Dean, Michael Summers, Chad Beck, James Harvey, Will McVally and Steven Scott. Manager: Mark McCollister; Coach: Kelly Beck.
CROWN CABLE

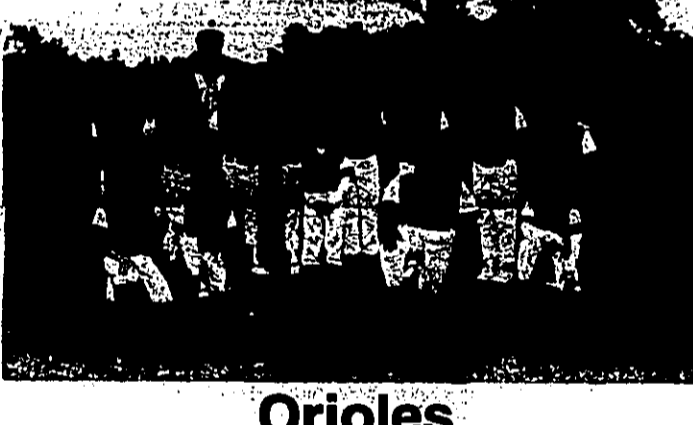

Orioles

Jacob Terrell, Travis Morris, Jarrod Buckner, Steven Riley, Tashia Jacobson, Christopher Linn, Kerigan Rivers, Jeremiah Coke, Timothy Wigley, Matthew Cyser and Bryan Davis. Sponsor: Wildwood Country Store; Manager: Martin Riley; Coaches: Keith Buckner, Danny Terrell and Randy Linn; Sweetheart: Amanda Riley; Team Mom: Theresa Morris.
WILDWOOD COUNTRY STORE



Padres

Dustin Stafford, Jed Townsend, Jonathon Gardner, Steven Reed, Trey Harvey, Jonathon Haynes, Seth Novak, Isaac Rodriguez, Quincy Mack, Frzadele Relondo, Ardian Hadnot and Shaun Reed. Manager: Randy Stafford; Coaches: Jerry Townsend and John Reed.
J&S DRUGS



Pirates

Chandalyn Lilley, Josh Ratchiff, Charles Lilley II, Joshua Arney, Robert Bates, Bradley Mott, Dustin Mitchell, Richard Gill, Jason Ogorodovic, Jimmy Grisson, Brian Griffith and Brian Owens. Manager: Martin K. Mott; Coach: James Ogorodovic.
TYLER COUNTY BOOSTER



Rangers

Joshua Toney, Jared Torrez, Brandon Johnson, Noel Hood, Ray Cook, Richard White, Justin Lira, Ross Wade Toler, Matthew Walker, Mark Torrez and Jarrod Davis. Manager: Bryan Davis; Coach: Gordon Zplet.
CHILDRESS MONUMENT

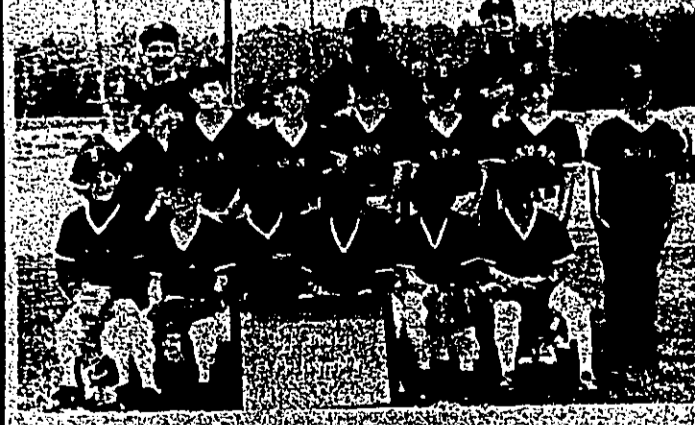

Red Sox

Jessica Decker, Joshua Lacy, Nathan Nichols, Blake Blanchette, Brandon Kinard, Ben Harris, Drew Tucker, Joseph Stafford, Dan Washington, William Ward, Chad Smith and Scott Herrington. Manager: Jimmy Tucker; Coaches: Jerry Nichols and Jackie Tucker.
WOODVILLE HARDWOOD



Rockies

Jordan Addison, P. J. Edwards, Nicholas Foret, Chris Caillier, Emily Rogers, Justin Burns, Billy Joe Carter, Derek Hardin, Ross Johnston, Marty Nash and Matt Wiggins. Sponsor: Shades Of Jed/Daniel Burns; Manager: Martin Nash; Coaches: Billy Wiggins and Daniel Burns; Sweetheart: Emily Rogers; Team Mom: Debbie Addison and Rhonda Johnson.
WOODVILLE HARDWOOD



White Sox

Brian Martin, T. J. Starock, Joshua Cruse, Billy Lewis, Brian Chatman, Clay Hensarling, Jay Clinton, Adam Grisson, John Christian, Bronson Grimes, Patrick Hadnot and Steven English. Manager: Phillip Martin; Coach: Tommy Hensarling.
G.W. LOGGING

TYLER COUNTY MAJOR LITTLE LEAGUE



Astros

Timothy Durr, Jeff Davis, Rott Parker, Bryan Gay, Jesse Gay, Jimmy Kirk, Samuel Pate, Robert Watson, Jess Payne, Damon Ratcliff, Kevin Barby, Richard Barnhart, Wesley Fowler and Brian Hough. Manager: Tim Durr; Coach: Ross Davis.
COMMUNITY BANK



Major Sweethearts

Leah Bearden, Jennifer Loupe, Bridgette Snider, Mary Ann Gay, Samantha Bible, Pamela Taylor, Fawn Bullock and Jennifer Loving.

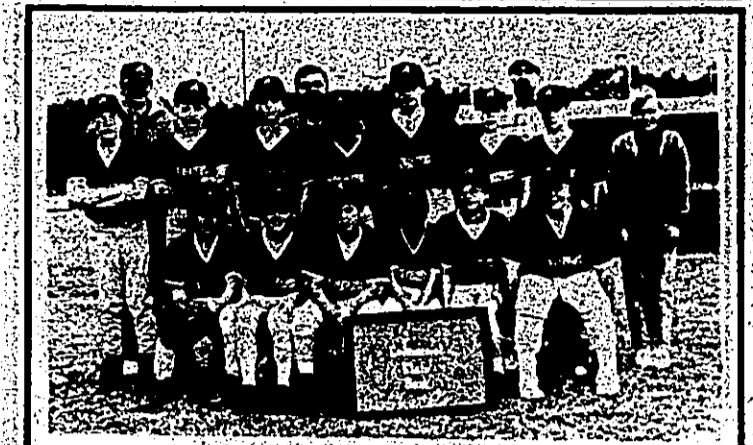

Braves

Blake Belt, Zach Ward, Aron Pickens, Ryan Hightower, Jesse Mahan, Jason Gibbs, Whit Harris, Roderick Douglas, John Knox II, Ricky Martin, Kevin Pentecost, Blake Pentecost and Chad Harry. Manager: Mark Martin; Coach: Elton Hightower.
1ST STATE BANK, COLMESNEIL

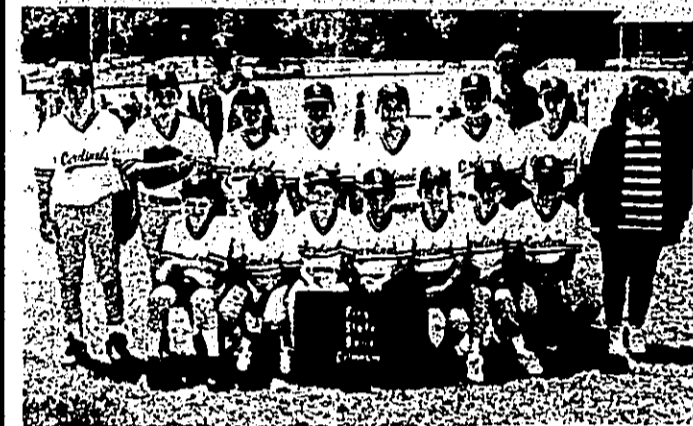

Cardinals

Jeremy Brown, Michael Patrick, Brad Carter, Matthew Wilkinson, Chad Patrick, Joshua Brown, Cody Worthy, Cole Crews, Shane Daniels, Andrew Halo, Bobby Foxworth, David Mahan, Josh Marshall and Daniel Fowler. Manager: Maxwell Fowler; Coach: Danny Worthy.
1ST STATE BANK, COLMESNEIL

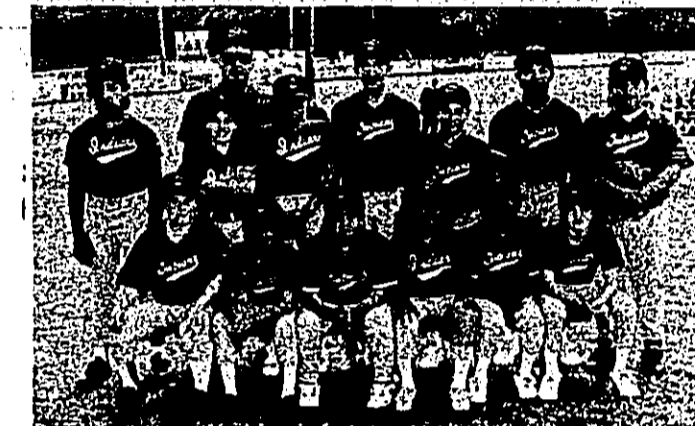

Indians

Colin Poncho, Rodman Syestine, Elliott Abbey, Patrick, Patrick Battise, James Thompson, Jordan Williams, Travis Crosby, Bradley Walker and Tobine Alec. Coach: Alton Lee Syestine.
INDIAN RESERVATION



Dodgers

Caleb Black, Scooter Ard, Christopher Grant, Jonathan Moore, Brian Yawn, Scott McAbee, Dwight Sanford, Adam Beugh, Lance Squires, Timothy Hooper, J. P. Bearden and Matt Dees. Sponsor: Rice Grocery; Manager: Steve Black; Coaches: Clyde Bearden, Gary Lachance, Prentice Black and Shaun Black; Sweetheart: Leah Bearden; Team Mom: Terri Yawn and Nancy Beugh.
RICE GROCERY



Mets

David Davis, Christopher Dotson, John Grimes, Stephen Haynes, Jason Hickman, Travis Lacox, Jarod Odom, John Sowarby, Cody Tillerson, Cecil Wade, Tom Wood, Michael Hanna and Bobby R. Cauley. Manager: Paul Wade; Coach: Tommy Tillerson.
FEW READY MIX

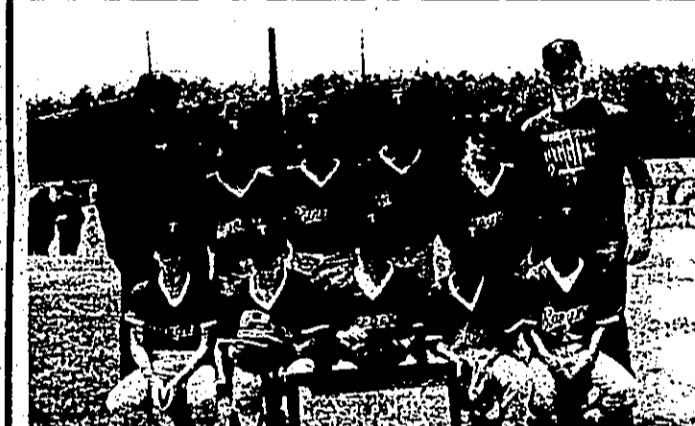

Rangers

Cory Whitworth, Matt Bryan, Derrick Reggie, Brandon Reggie, Keith Jones, Jonathan Barnes, Jacob Standley, James Ray Kimball, Antwan Morris and Tim Daniels. Manager: Bob Davis; Coach: Chris Bailey.
WOODVILLE HARDWOOD



Rockies

Matthew Adams, Cuyler Zimmerman, Josh Coke, Paul Loupe, Josh Nichols, Kirk Foret, Fredrick Dunham, J.P. Landry, Justin Ray, Joshua Mulder and Dane Tipton. Sponsor: Coke Enterprises; Manager: Mitchell Zimmerman; Coaches: Bobby Nichols and Courtney Zimmerman; Sweetheart: Jennifer Loupe; Team Mom: Renee Zimmerman.
TYLER COUNTY TRACTOR



Tigers

Michael Barlow, Paul J. Berryman, Brandon Cruse, Jeffery Wayne Cruse, Tony Easter, Roy Glenn Gay, James Hafra, Greg Harwell, Calvin Brian Hough, Evan Lunc, Michael Parish, Robert Lynn Prosperie, Joshua J. Williams and Brent Allen. Manager: Alton Harwell; Coach: Matt Bochal.
E&L LUMBER COMPANY

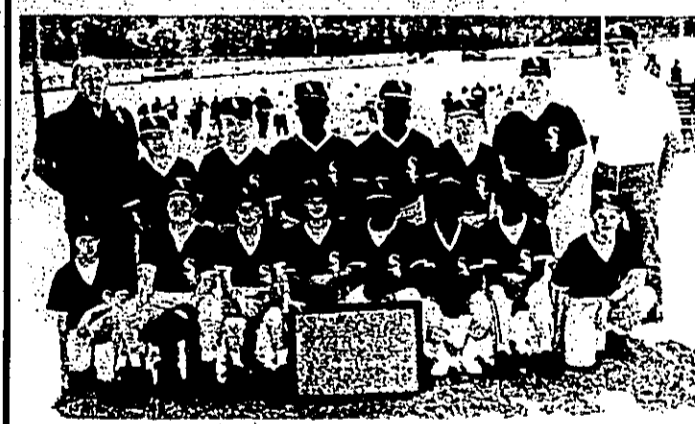

White Sox

Bela Nagypal, Michael Evans, Chad Johnson, Clinton Greer, Josh Byron, Jason Scott, Brad Wise, Robert Hughes, Danlony Cook, Adam Brochtup, Orin Dean, Lucas Brown, Justin Scott and Chevis Smith. Manager: Bela Nagypal; Coach: Steve Evans.
KELLER



Yankees

Corry Bean, Chlon Blake, Monty Dattalo, Chase Farr, Trey Grammer, Jeremy Hall, C. D. Hicks, James Jackson, David Johnson, Jared Midkiff, Trey Scales, Brian Walker and Scott Ward. Manager: Tom Weisbrook.
A&M MOTOR COMPANY



Tyler County National League All Stars defeat Anhuac Saturday Night, 11-3.

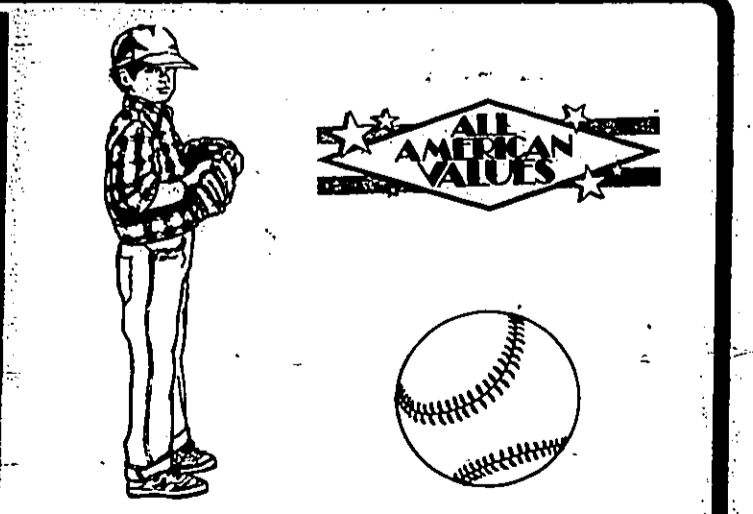

TYLER COUNTY GIRLS SOFTBALL SENIOR LEAGUE



Cowgirls

Grace Boykin, Michelle Parrish, Nicole Moya, Mary Garzaway, Chriss Brown, Beth Wilson, Kimberly Broom, Kassi Strickland, Allison Cruse, Jennifer Tolbert, Juanna Berryman, Stanci Hensarling, Eryn Byrum and Laura Kemerson. Sponsor: Rose Paint Center; Coaches: Bruce Strickland and Jimmy Cruse; Sweetheart: Curtis Judlet.

WOODVILLE HARDWOOD



Rascals

Rita Hough, Melanie Hughlett, Rachael Harvey, Jamie Shepherd, Jennifer Maxwell, Christina Allison, Charla Davis, Kemece Allen, Annec Allen, Tracy Greer, Kirsten Babin, Cassandra Mitchell, Amanda Mitchell and Laisha Humphrey. Sponsor: Allison Chevrolet; Coaches: Cindy Hensarling and Avoia Hough; Sweetheart: Ricky Fortenberry.

ALLISON CHEVROLET



Colmesneil Sr.

Chelanie Shulls, Amanda Fowler, Candy Broom, Casey Snider, Alicia Fowler, Bridgette Jamail, Kaylee Toler, Rachel Thompson, Heather Flowers, Tiffany Parker, Crystal Pittman, Jennifer Reynolds and Sabrina Melson. Sponsor: Allison Chevrolet; Coaches: Ricky Coker and Cecilia Reynolds; Sweetheart: Heather Flowers.

ALLISON CHEVROLET

TYLER COUNTY GIRLS SOFTBALL BIG LEAGUE

T-Ball	Girls Softball Final		Tie
	W	L	
Blazer	8	0	
Little Rascals	5	2	1
Mustangs	5	3	
Lady Jacks	1	5	2
Tornados	1	6	1
Little League			Tie
Red Babes	16	0	
C & C	13	3	
Cheetahs	12	4	
Martins	9	7	
Blue Jays	8	8	
Yellow Jackets	8	8	
Daisy Dukes	2	13	1
Lady Bugs	2	14	
Terminators	1	14	1
Senior League	W	L	Tie
Rascals	9	5	
Cowgirls	9	5	
Colmesneil	3	11	
Big League	W	L	Tie
Rockettes	9	4	
Lady Jacks	8	5	



Rockettes

Amy Sanford, Misty Haynes, Olivia Sirban, Doretta Fortenberry, Rachel McKinney, Noelle Berryman, Jessica Browning, Jennifer Abbott, Krystal Davis, Angela Heath, Jennifer Pittman and Trina Horn. Sponsor: Knapp Ford; Coaches: David Davis and Ronnie Ford; Sweetheart: Krystal Davis.

KNAPP FORD

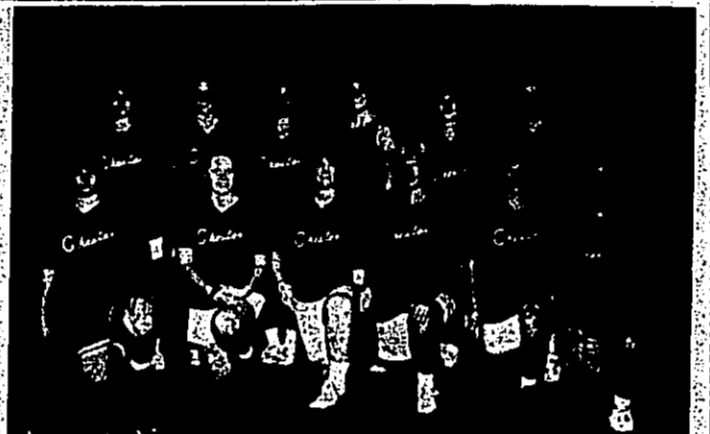

Lady Jacks

Karie Hubert, Stacy Whitworth, Laura Lowe, Adrienne Bryan, Jennifer Bryan, Elizabeth Ewings, Wendy Whitworth, Trina Collins, Amber Brown and Brandt Williams. Sponsor: Champion; Coaches: Bronson Williams and James Ewings; Sweetheart: Adrienne Bryan.

CHAMPION

SUPPORT ALL TYLER COUNTY BASEBALL AND SOFTBALL TEAMS!

Thanks To You Over 240 Girls Got to Play Softball This Season In Tyler County!

Farmers Feed
 Donald DuBose
 James Young
 Mike Stacey
 John Craine-
 Keller Industries
 E & L Lumber Co.
 James Collier
 Boykin Lumber
 Rose Paint Center
 McCoy Tree Service
 Knapp Ford Sales, Inc.
 Allison Chevrolet
 Pete Barnes
 Champion International
 Woodville Lions Club

Tyler County Sheriff's
 Activity League
 Davis Davis
 After Affects
 Arthur Bean
 A to Z Auto Parts
 Woodville Electric
 Woodville Veterinary Clinic
 Mr and Mrs Irvin
 Monk Investigation
 Donnie Poindexter
 Ladies Auxiliary
 McWaters Trucking
 Louisiana Pacific
 Walter Umphrey
 1st State Bank-Colmesneil

Wal-Mart

1121 S. Magnolia, Woodville, Texas. HOURS: Mon-Sat: 8 am - 9 pm, Sun: 10-6



WAL-MART'S ADVERTISED MERCHANDISE POLICY: It is our intention to have every advertised item in stock. However, if due to any unforeseen reason, an advertised item is not available for purchase, Wal-Mart will issue a Rain Check on request, for the merchandise to be purchased at the sale price whenever available, or will send you a similar item at a comparable reduction in price. We reserve the right to limit quantities. Limitations void in New Mexico.



TYLER COUNTY GIRLS SOFTBALL T-BALL

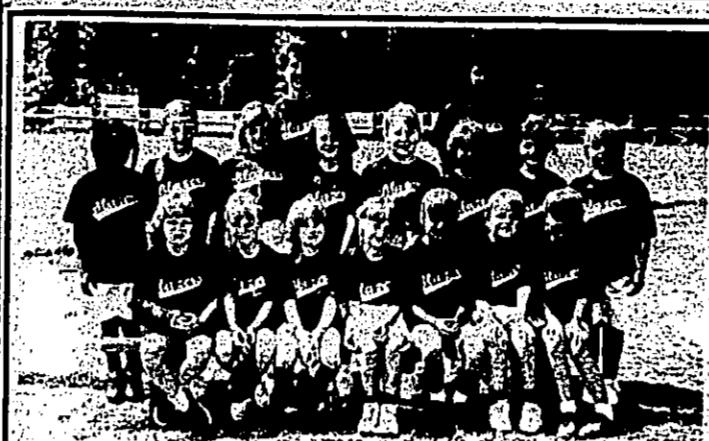

Blazers

Kyndal Howard, Missy Watters, Melissa Cheney, Patricia Sutton, Suzanna Sutton, JaVonna Pittman, LaShawna Butler, Selena Baird, Jessica Baird, Michelle Reynolds, Melissa Reynolds, Marylyn Gibbs, Ashley Aday and Alyson Rainey. Sponsor: Allison Chevrolet; Coaches: Ernestine Watters and Kandl Howard; Sweetheart: Melissa Cheney.

ALLISON CHEVROLET



Tornados

Keri Dennard, Mary Dennis, Whitney Hensarling, Ashley Irvin, Jessica McCoy, Crystal McNeil, Sarah Odom, Emily Starkey, Krystle Yarn, Heather Allen-Worthy and Alyssa Yancey. Sponsor: Mr. & Mrs. Irvin, Donnie Poindexter, Monk Investigation; Coach: Amy McCoy; Sweetheart: Ashley Irvin.

FDIC CITIZENS STATE BANK



Mustangs

Jessica Ratcliff, Blaire Blancheite, Laura Babin, Britany Bean, Danielle Bean, Erin Rainey, Brandi Laime, Sica Simpson, Robin Dook, Autumn Hall, Danielle Skinner, Amber Rainey and Jena Rainey. Sponsor: Lady's Auxiliary; Coaches: Lyle Rainey and Debbie Skinner; Sweetheart: Erin Rainey.

INDIAN RESERVATION



Lady Jacks

Marie Clowers, Jennifer Dunkin, Candice Erwin, Hilary Graham, Tamara Herrington, Traci Laco, Shelly Lay, Tany Maxwell, Chelsea Monzingo, Carmen Pickett, Summer Talbot and Ashley Worthy. Sponsor: McWaters Trucking; Coach: Teresa Dunkin; Sweetheart: Chelsea Monzingo.

MAGNOLIA APPLIANCE

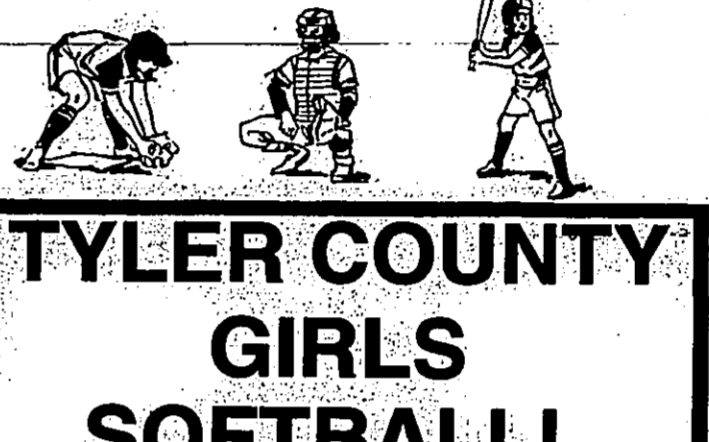

TYLER COUNTY GIRLS SOFTBALL LITTLE LEAGUE

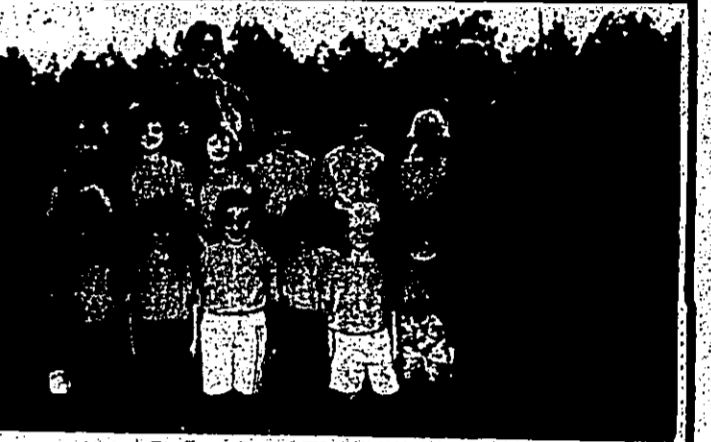

Little Rascals

Corby Weyler, Tannah Burns, Cassie Ogden, Ashley Downs, Ashly Smith, Brandi Foxworth, Leslee Rogers, Jessica Williams, Nicki McCollum, Brandi Wise, Amber Wigley, Autumn Caldwell, Heather Morris, LeAnne Barclay, Courtney Bainbridge and Leah Eliff. Sponsor: After Affects; Coaches: Holly Weyler and Sherlyon Burns; Sweetheart: Ashley Downs.

AFTER AFFECTS



Lady Bugs

Carla Daniel, Renee Barnes, Michelle Barnes, Monica Woodruff, Stephanie McCasland, Jana Hubert, Emily Payne, Margie McCarty, Elizabeth Founds and Jennifer Whitfield. Sponsor: Champion; Coaches: Carolyn Daniel and Deby Barnes; Sweetheart: Elizabeth Founds.

CHAMPION

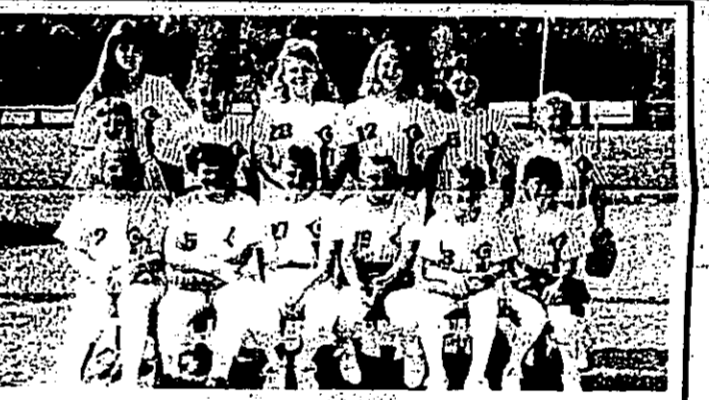

Cheetahs

Ashley Flowers, Cassie Flowers, Courtney Flowers, Kimberly Lucas, Jessica Standley, Jessilyn Davis, Josi Rawls, Wendy Franks, Krystal Cook, Stephanie Parker, Christine Parker and Becki Loftin. Sponsor: Champion; Coaches: Sue Flowers and Cary Lucas; Sweetheart: Josie Rawls.

CHAMPION



C & C Allstars

Katrina Corn, Ashley Tibbetts, Laura Wooten, Sharon Crawford, Samantha Potts, Michelle Meadows, Amy Dabose, Michelle Johnson, Ashlee Bainbridge, Brandi Wood and Jessica Sisson. Sponsor: E & L Lumber; Coaches: Virginia Ponder and Berunda Broom; Sweetheart: Katrina Corn.

E&L LUMBER COMPANY



Daisy Dukes

Anna Coke, Bridgette Corn, Liz Mosby, Hope Murphy, Jamie Willis, Annie Young, Jessica Spiller, Rebecca Disler, Heather McGough, Choe McGough and Anna Roundtree. Sponsor: Louisiana Pacific; Coaches: Deway Coke and Billie Corp; Sweetheart: Bridgette Corn.

BOYKIN LUMBER COMPANY



Marlins

Michelle Barlow, Ashley Milam, Dianne Reid, Janay Wigley, Amber Courter, Kourtney Davis, Ashley Yancey, Jenny Reid, Candace Lamberth, Erin Dennis, Chantell Monzingo, Linda Hernandez and Tiffany McCullay. Sponsor: A-Z Auto Parts; Coaches: Otis Wigley and Ronnie Milam; Sweetheart: Chantell Monzingo.

KATRINA'S STYLING SALON



Terminators

Samantha Ponder, Amber Sanford, Jennifer Rucks, Telisha Wade, Kasey Broom, Hollie Broom, Courtney Broom, Aundrea Dabill, Jennifer Shelton, Diana Horn, Tasha Lee and April Tullos. Sponsor: Woodville Electric; Coaches: Virginia Ponder and Berunda Broom; Sweetheart and League Queen: Samantha Ponder.

1ST NATIONAL BANK FDU



Yellow Jackets

Heather Nesbitt, Catrina Weems, Lyssa Dennard, Krystle Czaplina, Jennifer Allen, Jennifer Broom, Tommie Foley, Ashley Gilchrist, Amy Carter, Mackenzie Paul, Stephanie Nix, Ailin Heaton and Latoya Hadron. Sponsor: Walter Umphrey; Coaches: Ron Dennard and Preston Broom; Sweetheart: Lyssa Dennard.

SURETY-BANK



Red Babes

Kaci Andrus, Charla Bendy, Miranda Cheney, Brittnie Crews, Ashley Danuser, Kelly Gallagher, Kristina Gallagher, Holly Robertson, Tishamah Ross, Bridgette Snider, Melissa Tompkins, Michelle Williams and Sonya Daniels. Sponsor: First State Bank - Colmesneil; Coach: Sharon Andrus; Sweetheart: Kelly Gallagher.

1ST STATE BANK, COLMESNEIL



Blue Jays

Misty Lott, Jessica Maxwell, Bridget Daitalo, Brandy O'Neal, Amy Brown, Jessica Smith, Leah Hargrave, April Hatton, Angela Youngblood, Lee Ann Hensarling, Amanda Fancher, Karen McCluskey and Amber Stafford. Sponsor: Woodville Veterinary Clinic; Coaches: Gordon McCuskey and Phillip Broom; Sweetheart: Brandy O'Neal.

YVONNE'S ANTIQUES

Thanks To You Over 700 Kids Got to Play Baseball This Season In Tyler County

Walter and Sheila Umphrey-\$45,000-
Lights on two new fields
T.L.L.Temple Foundation-\$30,000-Grant
Louisiana Pacific-\$10,000-
Boards and Wood for Stands
E & L Lumber Co.-\$3,000-Lights
Ron Poindexter-Metal for
dugouts and stands
Lindsey Whisenant-dugouts
Allan Bell-fence material
Troy Blakeney-\$2,500 fencing
Ken Baily, Attorney- Mower
Don Shaw-City of Woodville
Commissioners Court of Tyler County
Doctors and Physicians of Tyler County
-\$900 -Trophies
Woodville Inn
Rose Paint Center
Charlie Cox-Supervisor-Warren
Elton Hightower-Supervisor-Colmesneil
Marvin Mott-Supervisor-Spurger
Jim Whitworth-Supervisor-Chester
Dr. Clint O'Neal-Supervisor-
T-Ball & Pitchball
Jimmie Tucker-Supervisor-Minor
Tommy Weaver-Supervisor-
Major and Senior League
Richard Guillory-Minor League Umpires
Martin Riley-Major League Umpires
Pat Cherry and Luke Satterwhite-
Senior League and
Big League Umpires
Phillip Martin-Electric Lighting
Royce Best-Electric Lighting
Boykin Lumber
Phil Hart-Welding
Alton Tucker
Jacques Blanchette- Announcer
Patti Tucker-Scorekeeper
Sandy Ferguson-Queen's Race
Connie's Flower Shop-Flowers
John Pat White-Electronics
Karen Ivy-Concession Stand
McDonald's
Dairy Queen
Subway
Texas Metals
KVLL

THE TYLER COUNTY BOOSTER
Bob Boykin Photography

TEAM SPONSORS:

G.W. Logging: Minor White Sox
Crown Cable: Phillies T-Ball
RPM: Pirates T-Ball
Community Bank: Astros-Major
Davis Food, Col.: Braves-Major
Knapp Ford: Astros-T-Ball
East Texas Insurance: Reds-T-Ball
J & S Drugs: Padres-Major
Lindsey Whisenant, Attorney:
Mariners-Minor
Spindeltop Street Rods: Rockies-T-Ball
Satterwhite Pharmacy: Blue Jays-T-Ball
Hensarling Mobil: Mets-Major
Davis Food, Warren: Rockies-Major
Hatton Logging: Pirates-Major
Davis: Grocery: Braves-Minor
Dr. Clint O'Neal: Tigers-T-Ball
A & M Motor Company: Yanks-Major
Chester Lions: Rangers-Minor
Bob's Photo: Red Sox-Minor
State Farm Insurance: Mets -T-Ball
Citizen's State Bank: Tigers-Major
1st State Bank-Colmesneil: Cards-Major
Dr. Clint O'Neal: Tigers-T-Ball
Surety Bank: Chester-Rangers-T-Ball
Robert Woods, Attorney: Mets-Minor
V.F.W. Post 2033: Giants- Minor
Jarrott's Pharmacy: Royals-Pitchball
G & W. Logging: Cards-Pitchball
Keller Industries: White Sox-Major
Jasper Mack Truck Sales: Cards-Minor
Texas Metals: Orioles- Pitchball
Surety Bank-Chester: Cards-Major
Precision Enterprises: Astros Pitchball

SENIOR LEAGUE SPONSORS:

Woodville Rotary Club
Woodville Lions Club
Jerry Rains
Satterwhite Pharmacy
Robert Woods, Attorney

Brookshire Bros.

LOWER FOOD PRICES



OPEN SUNDAY
8-4
MONDAY THRU
SATURDAY 7-4

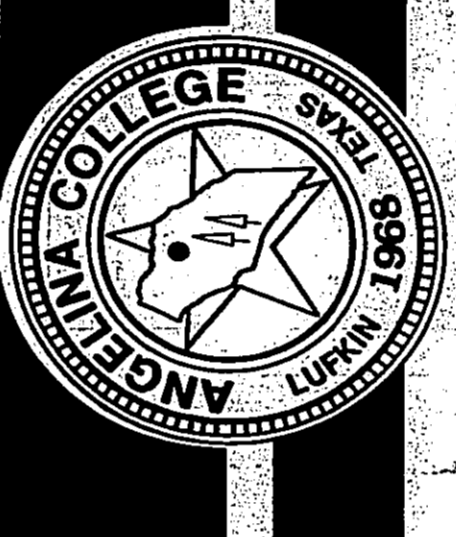
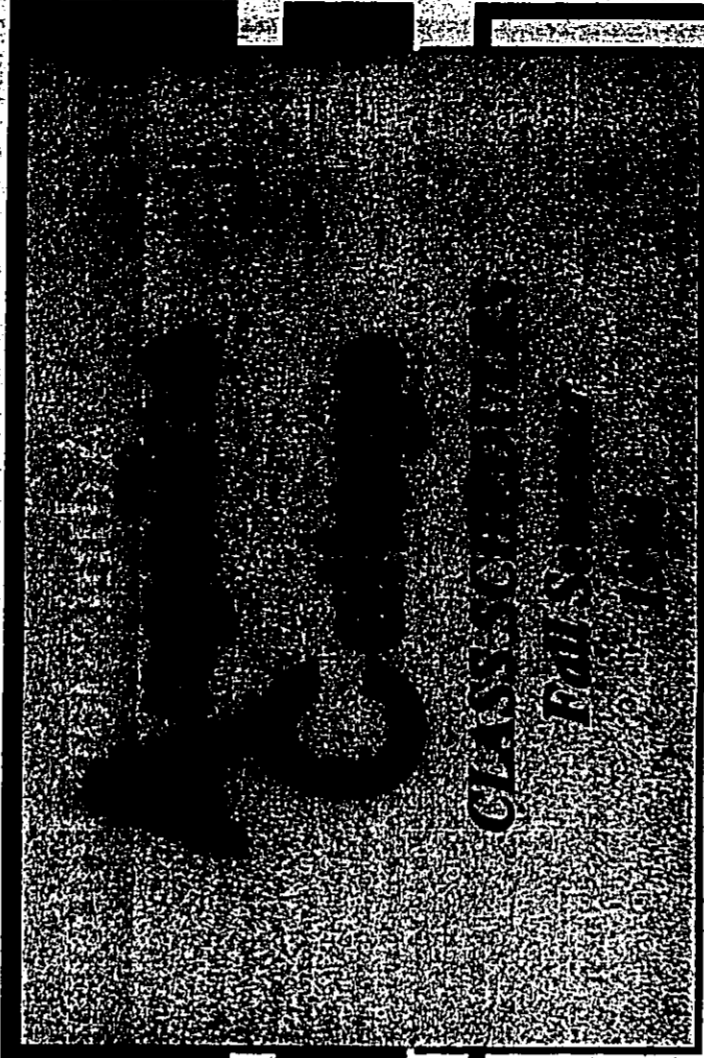

How to Register

New Students
Apply for admission
Submit an application to the Admissions Office
Receive a letter of intent from the Admissions Office
Submit a deposit to the Admissions Office
Get a permit to register (page 2)
Apply for financial aid (Student Center, Room 208)
Take placement tests to assess your basic academic skills (Student Center, Room 208)
Return your books (Student Center, Room 208)
Register for classes (Student Center, Room 208)

Important Dates To Remember:
July 25: Early Fall Registration
July 25: Fall registration permits available in Admissions Office
Aug. 2: ASSET Testing for all Fall Semester orientation students
Aug. 4: Last day of early fall registration fee payment. Failure to pay fees by deadline will result in cancellation of registration.
Aug. 4 or 5: Freshman orientation, advisement and registration
Aug. 15: 17 Off-Campus registration for Fall Semester
Aug. 21: Dormitory Check-in 1 p.m. - 4 p.m.
Aug. 22: General Faculty Meeting
Aug. 23: ASSET Testing 5:30 p.m.
Aug. 24: Fall Semester registration 8:30 a.m.-8:30 p.m.; Permit only
Aug. 25: Fall Semester registration; 8:30 a.m.-6:30 p.m.; Permit only
Aug. 26: First day of late registration
Aug. 30: Registration ends
Aug. 31: ASSET Testing 8:30 a.m.
Sept. 1: Last day of schedule changes
Sept. 5: Labor Day Holiday
Sept. 14: Twelfth Class Day
Sept. 26: Last day to withdraw with a partial refund
Sept. 26: Last day to withdraw from all drop classes
Oct. 3: Mid-semester
Nov. 21: Thanksgiving Holidays
Nov. 21: Last day to register for December graduation
Nov. 28: Early Registration for Spring 1995 begins
Nov. 28: Last day to withdraw from or drop classes
Dec. 9-15: Final Exams
Angelim College, P.O. Box 1768, Lufkin Texas 75902 (409) 634-1301

Angelim College admits students without regard for race, color, creed, sex, age, national origin, or disability. Questions or requests for more information should be directed to Dr. Patricia McKeate at (409) 634-1301.

How to Register

New Students
Apply for admission
Submit an application to the Admissions Office
Receive a letter of intent from the Admissions Office
Submit a deposit to the Admissions Office
Get a permit to register (page 2)
Apply for financial aid (Student Center, Room 208)
Take placement tests to assess your basic academic skills (Student Center, Room 208)
Return your books (Student Center, Room 208)
Register for classes (Student Center, Room 208)

Angelim College admits students without regard for race, color, creed, sex, age, national origin, or disability. Questions or requests for more information should be directed to Dr. Patricia McKeate at (409) 634-1301.

TECHNICAL-VOCATIONAL DIVISION

Course No.	Section	Course Description	Fee	Time	Day	Instructor	Room
1101	1101	Math I	\$15	8:00-9:00	T	Staff	TBA
1102	1102	Math II	\$15	8:00-9:00	T	Staff	TBA
1103	1103	Math III	\$15	8:00-9:00	T	Staff	TBA
1104	1104	Math IV	\$15	8:00-9:00	T	Staff	TBA
1105	1105	Math V	\$15	8:00-9:00	T	Staff	TBA
1106	1106	Math VI	\$15	8:00-9:00	T	Staff	TBA
1107	1107	Math VII	\$15	8:00-9:00	T	Staff	TBA
1108	1108	Math VIII	\$15	8:00-9:00	T	Staff	TBA
1109	1109	Math IX	\$15	8:00-9:00	T	Staff	TBA
1110	1110	Math X	\$15	8:00-9:00	T	Staff	TBA
1111	1111	Math XI	\$15	8:00-9:00	T	Staff	TBA
1112	1112	Math XII	\$15	8:00-9:00	T	Staff	TBA
1113	1113	Math XIII	\$15	8:00-9:00	T	Staff	TBA
1114	1114	Math XIV	\$15	8:00-9:00	T	Staff	TBA
1115	1115	Math XV	\$15	8:00-9:00	T	Staff	TBA
1116	1116	Math XVI	\$15	8:00-9:00	T	Staff	TBA
1117	1117	Math XVII	\$15	8:00-9:00	T	Staff	TBA
1118	1118	Math XVIII	\$15	8:00-9:00	T	Staff	TBA
1119	1119	Math XIX	\$15	8:00-9:00	T	Staff	TBA
1120	1120	Math XX	\$15	8:00-9:00	T	Staff	TBA
1121	1121	Math XXI	\$15	8:00-9:00	T	Staff	TBA
1122	1122	Math XXII	\$15	8:00-9:00	T	Staff	TBA
1123	1123	Math XXIII	\$15	8:00-9:00	T	Staff	TBA
1124	1124	Math XXIV	\$15	8:00-9:00	T	Staff	TBA
1125	1125	Math XXV	\$15	8:00-9:00	T	Staff	TBA
1126	1126	Math XXVI	\$15	8:00-9:00	T	Staff	TBA
1127	1127	Math XXVII	\$15	8:00-9:00	T	Staff	TBA
1128	1128	Math XXVIII	\$15	8:00-9:00	T	Staff	TBA
1129	1129	Math XXIX	\$15	8:00-9:00	T	Staff	TBA
1130	1130	Math XXX	\$15	8:00-9:00	T	Staff	TBA
1131	1131	Math XXXI	\$15	8:00-9:00	T	Staff	TBA
1132	1132	Math XXXII	\$15	8:00-9:00	T	Staff	TBA
1133	1133	Math XXXIII	\$15	8:00-9:00	T	Staff	TBA
1134	1134	Math XXXIV	\$15	8:00-9:00	T	Staff	TBA
1135	1135	Math XXXV	\$15	8:00-9:00	T	Staff	TBA
1136	1136	Math XXXVI	\$15	8:00-9:00	T	Staff	TBA
1137	1137	Math XXXVII	\$15	8:00-9:00	T	Staff	TBA
1138	1138	Math XXXVIII	\$15	8:00-9:00	T	Staff	TBA
1139	1139	Math XXXIX	\$15	8:00-9:00	T	Staff	TBA
1140	1140	Math XXXX	\$15	8:00-9:00	T	Staff	TBA
1141	1141	Math XXXXI	\$15	8:00-9:00	T	Staff	TBA
1142	1142	Math XXXXII	\$15	8:00-9:00	T	Staff	TBA
1143	1143	Math XXXXIII	\$15	8:00-9:00	T	Staff	TBA
1144	1144	Math XXXXIV	\$15	8:00-9:00	T	Staff	TBA
1145	1145	Math XXXXV	\$15	8:00-9:00	T	Staff	TBA
1146	1146	Math XXXXVI	\$15	8:00-9:00	T	Staff	TBA
1147	1147	Math XXXXVII	\$15	8:00-9:00	T	Staff	TBA
1148	1148	Math XXXXVIII	\$15	8:00-9:00	T	Staff	TBA
1149	1149	Math XXXXIX	\$15	8:00-9:00	T	Staff	TBA
1150	1150	Math XXXXX	\$15	8:00-9:00	T	Staff	TBA
1151	1151	Math XXXXXI	\$15	8:00-9:00	T	Staff	TBA
1152	1152	Math XXXXXII	\$15	8:00-9:00	T	Staff	TBA
1153	1153	Math XXXXXIII	\$15	8:00-9:00	T	Staff	TBA
1154	1154	Math XXXXXIV	\$15	8:00-9:00	T	Staff	TBA
1155	1155	Math XXXXXV	\$15	8:00-9:00	T	Staff	TBA
1156	1156	Math XXXXXVI	\$15	8:00-9:00	T	Staff	TBA
1157	1157	Math XXXXXVII	\$15	8:00-9:00	T	Staff	TBA
1158	1158	Math XXXXXVIII	\$15	8:00-9:00	T	Staff	TBA
1159	1159	Math XXXXXIX	\$15	8:00-9:00	T	Staff	TBA
1160	1160	Math XXXXXX	\$15	8:00-9:00	T	Staff	TBA

OFF-CAMPUS TEACHING CENTERS

HOUSTON TEACHING CENTER

Course No.	Section	Course Description	Fee	Time	Day	Instructor	Room
1101	1101	Math I	\$15	8:00-9:00	T	Staff	TBA
1102	1102	Math II	\$15	8:00-9:00	T	Staff	TBA
1103	1103	Math III	\$15	8:00-9:00	T	Staff	TBA
1104	1104	Math IV	\$15	8:00-9:00	T	Staff	TBA
1105	1105	Math V	\$15	8:00-9:00	T	Staff	TBA
1106	1106	Math VI	\$15	8:00-9:00	T	Staff	TBA
1107	1107	Math VII	\$15	8:00-9:00	T	Staff	TBA
1108	1108	Math VIII	\$15	8:00-9:00	T	Staff	TBA
1109	1109	Math IX	\$15	8:00-9:00	T	Staff	TBA
1110	1110	Math X	\$15	8:00-9:00	T	Staff	TBA
1111	1111	Math XI	\$15	8:00-9:00	T	Staff	TBA
1112	1112	Math XII	\$15	8:00-9:00	T	Staff	TBA
1113	1113	Math XIII	\$15	8:00-9:00	T	Staff	TBA
1114	1114	Math XIV	\$15	8:00-9:00	T	Staff	TBA
1115	1115	Math XV	\$15	8:00-9:00	T	Staff	TBA
1116	1116	Math XVI	\$15	8:00-9:00	T	Staff	TBA
1117	1117	Math XVII	\$15	8:00-9:00	T	Staff	TBA
1118	1118	Math XVIII	\$15	8:00-9:00	T	Staff	TBA
1119	1119	Math XIX	\$15	8:00-9:00	T	Staff	TBA
1120	1120	Math XX	\$15	8:00-9:00	T	Staff	TBA
1121	1121	Math XXI	\$15	8:00-9:00	T	Staff	TBA
1122	1122	Math XXII	\$15	8:00-9:00	T	Staff	TBA
1123	1123	Math XXIII	\$15	8:00-9:00	T	Staff	TBA
1124	1124	Math XXIV	\$15	8:00-9:00	T	Staff	TBA
1125	1125	Math XXV	\$15	8:00-9:00	T	Staff	TBA
1126	1126	Math XXVI	\$15	8:00-9:00	T	Staff	TBA
1127	1127	Math XXVII	\$15	8:00-9:00	T	Staff	TBA
1128	1128	Math XXVIII	\$15	8:00-9:00	T	Staff	TBA
1129	1129	Math XXIX	\$15	8:00-9:00	T	Staff	TBA
1130	1130	Math XXX	\$15	8:00-9:00	T	Staff	TBA
1131	1131	Math XXXI	\$15	8:00-9:00	T	Staff	TBA
1132	1132	Math XXXII	\$15	8:00-9:00	T	Staff	TBA
1133	1133	Math XXXIII	\$15	8:00-9:00	T	Staff	TBA
1134	1134	Math XXXIV	\$15	8:00-9:00	T	Staff	TBA
1135	1135	Math XXXV	\$15	8:00-9:00	T	Staff	TBA
1136	1136	Math XXXVI	\$15	8:00-9:00	T	Staff	TBA
1137	1137	Math XXXVII	\$15	8:00-9:00	T	Staff	TBA
1138	1138	Math XXXVIII	\$15	8:00-9:00	T	Staff	TBA
1139	1139	Math XXXIX	\$15	8:00-9:00	T	Staff	TBA
1140	1140	Math XXXX	\$15	8:00-9:00	T	Staff	TBA
1141	1141	Math XXXXI	\$15	8:00-9:00	T	Staff	TBA
1142	1142	Math XXXXII	\$15	8:00-9:00	T	Staff	TBA
1143	1143	Math XXXXIII	\$15	8:00-9:00	T	Staff	TBA
1144	1144	Math XXXXIV	\$15	8:00-9:00	T	Staff	TBA
1145	1145	Math XXXXV	\$15	8:00-9:00	T	Staff	TBA
1146	1146	Math XXXXVI	\$15	8:00-9:00	T	Staff	TBA
1147	1147	Math XXXXVII	\$15	8:00-9:00	T	Staff	TBA
1148	1148	Math XXXXVIII	\$15	8:00-9:00	T	Staff	TBA
1149	1149	Math XXXXIX	\$15	8:00-9:00	T	Staff	TBA
1150	1150	Math XXXXXX	\$15	8:00-9:00	T	Staff	TBA

HOUSTON TEACHING CENTER

Course No.	Section	Course Description	Fee	Time	Day	Instructor	Room
1101	1101	Math I	\$15	8:00-9:00	T	Staff	TBA
1102	1102	Math II	\$15	8:00-9:00	T	Staff	TBA
1103	1103	Math III	\$15	8:00-9:00	T	Staff	TBA
1104	1104	Math IV	\$15	8:00-9:00	T	Staff	TBA
1105	1105	Math V	\$15	8:00-9:00	T	Staff	TBA
1106	1106	Math VI	\$15	8:00-9:00	T	Staff	TBA
1107	1107	Math VII	\$15	8:00-9:00	T	Staff	TBA
1108	1108	Math VIII	\$15	8:00-9:00	T	Staff	TBA
1109	1109	Math IX	\$15	8:00-9:00	T	Staff	TBA
1110	1110	Math X	\$15	8:00-9:00	T	Staff	TBA
1111	1111	Math XI	\$15	8:00-9:00	T	Staff	TBA
1112</							

APPLICATION FOR ADMISSION
 ANGELINA COLLEGE, P.O. BOX 1766, LUFKIN, TEXAS 75902-1766
 PLEASE PRINT

1 Full legal name _____
 Last First Middle
 Social Security Number _____ Phone Number (_____)
 Local Address _____ Street/Box _____ City _____ State _____ Zip _____
 Permanent Address _____ Street/Box _____ City _____ State _____ Zip _____
 Place of Birth _____ City _____ State _____
 Hometown Newspaper _____ City _____ State _____

2 How long have you lived in Angelina County? _____ in Texas? _____ in U.S.? _____
 Do you or your parents own land in Angelina County? Circle One: Yes No
 Are you a U.S. citizen? Circle One: Yes No Permanent Resident Visa: Yes No
 3 Semesters you plan to enter Angelina College. Circle One: Fall Spring Summer II Summer III
 What course of study do you plan to pursue? (Major or Interest) _____
 High school course attended: _____ Location _____ City _____ State _____
 Did you graduate? Yes No If no, give date _____ If yes, give year _____
 Have you taken the Texas Academic Skills Program (TASP) test? Yes No
 List all colleges and universities in which you have been officially enrolled, include dates of attendance and degrees (if any) with dates. Failure to list all colleges attended will be considered an omission and lead to removal of admission without refund.
 Name of College or University _____ City _____ State _____ Dates Attended _____ Degrees Earned _____

4. If your claim for residence status is based upon parent or legal guardian, please answer the following questions:
 (a) Name of person upon whom claim is based: _____
 (b) Relationship to self: _____
 (c) How long has the person resided in Texas? _____ Years and _____ Months
 (d) Previous state or county of residence: _____
 (e) If this person came here within the past 3 years, why did this person move to Texas?
 (f) Is this person a U.S. citizen? Yes No
 (g) Has parent or legal guardian claimed you as a dependent for U.S. federal income tax purposes for the tax year preceding your registration? Yes No
 (h) If not, when was the last time you were claimed for the current tax year? Yes No _____
 5. If your claim for residence status is based upon your own effort, please answer the following questions:
 (a) Name of person upon whom claim is based: _____
 (b) Relationship to self: _____
 (c) How long has the person resided in Texas? _____ Years and _____ Months
 (d) Previous state or county of residence: _____
 (e) If this person came here within the past 3 years, why did this person move to Texas?
 (f) Is this person a U.S. citizen? Yes No
 (g) Has parent or legal guardian claimed you as a dependent for U.S. federal income tax purposes for the tax year preceding your registration? Yes No
 (h) If not, when was the last time you were claimed for the current tax year? Yes No _____

PROOF OF RESIDENCY
 In addition to the above information, Angelina College requires the following documentation to prove your residence status for admission and residency eligibility. Submission of the college/university's verification bills (FOR AT-LAST ONE YEAR) and U.S. Census Bureau records (FOR AT-LAST ONE YEAR) are required. Failure to submit this information will result in the denial of admission and residency status.
 I acknowledge by my signature that false information furnished on this application for admission may lead to disqualification of all students and fees.
 Signature _____ Date _____
 Social Security Number _____
 Angelina College does not discriminate on the basis of color, race, sex, age, marital status, or national origin.
 FOR OFFICE USE ONLY
 Admissions Office _____ Phone: _____

Course No.	Section	Course Description	Fee	Lab	Time	Days	Instructor	Room
AGRI 11810		Animal Production	\$6		8:30-12:30M		Ward	815
BIO 10401		General Biology	\$6		11:25-12:45P		Ward	817
BIO 10402		General Biology	\$6		11:25-12:45P		Ward	818
CHEN 10401		General Chemistry	\$6		11:25-12:45P		Ward	820
CHEN 10402		General Chemistry	\$6		11:25-12:45P		Ward	821
CHEN 11001		Gen. Inorganic Chemistry	\$6		11:25-12:45P		Ward	822
CHEN 11002		Gen. Inorganic Chemistry	\$6		11:25-12:45P		Ward	823
ENGR 10101		Intro. to Engg. I	\$15		8:30-12:30M		Ward	815
ENGR 10102		Intro. to Engg. I	\$15		8:30-12:30M		Ward	816
ENGR 10201		Intro. to Engg. II	\$15		8:30-12:30M		Ward	817
ENGR 10202		Intro. to Engg. II	\$15		8:30-12:30M		Ward	818

Admission Information

ANGELINA COLLEGE
 LUFKIN, TEXAS 75902-1766
 (409) 633-5312

Call the Admissions Office
 M-F 8 a.m. - 5 p.m.

THE PHONE REGISTRATION CENTER is available for assistance 24 hours a day. Call toll-free 1-800-543-6333.

ANGELINA COLLEGE is an equal opportunity institution. We do not discriminate in admission, employment, or other college activities on the basis of race, color, sex, age, marital status, or national origin.

ANGELINA COLLEGE is a member of the National Association of State Colleges and Universities (NASCU) and the National Association of State Technical Colleges and Universities (ASTECU).

ANGELINA COLLEGE is a member of the Texas College System and the Texas State Technical College System.

ANGELINA COLLEGE is a member of the Texas College System and the Texas State Technical College System.

ANGELINA COLLEGE is a member of the Texas College System and the Texas State Technical College System.

ANGELINA COLLEGE is a member of the Texas College System and the Texas State Technical College System.

ANGELINA COLLEGE is a member of the Texas College System and the Texas State Technical College System.

ANGELINA COLLEGE is a member of the Texas College System and the Texas State Technical College System.

ANGELINA COLLEGE is a member of the Texas College System and the Texas State Technical College System.

ANGELINA COLLEGE is a member of the Texas College System and the Texas State Technical College System.

Tyler County Church Listings

Adventist
Seventh Day Adventist Church
1 miles south of Warren, Highway 69
Rocky Guerro, Pastor

Agape
Agape Church
FM 1745 837-4434
Kenn and Gina Harrison, Pastors

Apostolic
Lakeside Apostolic Church
429-5481, Bro. Hershel Lott, Pastor

Assembly of God
Abundant Life Fellowship
Hwy. 190 at 92, Dam B, Tx. 283-3324
Rev. J.D. Hughes

First Assembly of God
R.C. Tiller, Pastor

Chester Assembly of God
Hwy. 287, Chester, 283-7862
Don Hensarling, Pastor

Colmesneil Assembly of God
Colmesneil, Texas 837-4424
J.C. Carter, Pastor

Hillster Assembly of God
Hillster, Texas 283-2725
Melvin D. McCallion, Pastor

Oak Grove Assembly of God
Hwy. 92 between Fred & Spurger
429-5050
Rev. Wayne Watts, Pastor

Shady Grove Assembly of God
West of Woodville
Trinity Christian Center
Hwy. 190 West, Woodville
283-5354
The Rev. William Stokessill, Pastor

Baptist
Aline Independent Baptist
1/8 miles E. of Doucette on FM3065
Buddy McDaniel, Pastor

Beech Creek Baptist Church
FM 1013, 3 miles west of Spurger,
Robert McClelland, Pastor

Bethany Baptist Church
Colmesneil, Texas
Rev. Jack Butler, Pastor

Bethel Baptist Church
Warren, Hwy. 1943 W. of 69
Dr. Don Richey Sr., Interim Pastor

Calvary Baptist Church
Hwy. 69 North, Woodville, Texas
Rev. Bill Ganther, Pastor

Cam Zion Baptist Church
Doucette, Texas
Rev. I.S. Hunt, Pastor

Caney Creek Baptist Church
Chester, Texas
G.M. Standley, Pastor

Chester Baptist Church
Chester, Jimmy Dean, Pastor

Dogwood Hills Baptist Church
Hwy. 190 West, Woodville
Rev. Troy A. Richardson, Pastor

Ebenezer Baptist Church
Colmesneil, Texas
Bro. Mike Ivory, Pastor

Emmanuel Baptist Church
2 miles N. of Doucette on Hwy. 69
Tommy Walker, pastor

Enon Baptist Church
4 miles E. of Chester on 1745
Henry Shettles, Pastor

Fairview Baptist Church
Hwy. 92, Town Bluff
Bro. Dan Magee, Pastor

Fellowship Primitive Baptist
C-547-2223
Elder O. Woodrow Wilson, Pastor

First Baptist Church, Colmesneil
Hwy. 69/256 West 837-5439
Bro. Michael Ledbetter, Pastor

First Baptist Church, Doucette
Doucette, Texas
Rev. Ken DeRouan, Pastor

First Baptist Church of Spurger
Spurger, Texas
David Nugent, Pastor

First Baptist Church, Warren
Warren, Texas
Kenneth Caubren, Pastor

First Baptist Church, Woodville
Corner of Wheat & Charlton 283-2588
Dr. Charles W. Hancy, Pastor

First Shiloh Baptist Church
Bro. Bert C. Sample, Pastor

Grace Baptist Church
Fowler Rd., 3 1/2 miles E. of Colmesneil
off FM 256, 283-3952; G.W. Patrick, Pastor

Harmony Baptist Church
FM 236, off Highway 190 West
Bro. Steve Ford, Pastor

Hebron Baptist Church
5 miles south of Warren, Hwy. 69
Hillster Baptist Church
Hillster, Texas
W.R. "Bill" Swearingen, Pastor

Hilltop Baptist Church
Hwy. 190, west of Dam B
Kenn Friecland, Pastor

Katy Baptist Church
Colmesneil, Texas - 837-2022
Durl Patrick, Pastor

Little Baptist Missionary Church
1 mile east on FM 1013
Rev. Bobby Cuss, Pastor

Little Flick Missionary Baptist Church
Hillster, Texas, 547-3336
Rev. T. Green, Pastor

Midway Missionary Baptist
FM 1943, 1/2 miles E. of Warren
Bro. E.C. Jones, Pastor

Mt. Carmel Baptist Church
Colmesneil, Texas
Jack Lewellen, Pastor

Mt. Hope Missionary Baptist
Rev. Edward Gambell, Pastor

Mount Nebo Baptist Church
FM 236, 1.3 miles E. Warren
Derrrel Young, Pastor

Mount Olivet Baptist Church
Hwy. 92, Fred, Texas
Brian Hale, Pastor

Mt. Sinai Baptist Church
Holly Fork Community
Bro. Charles Haynes, Interim Pastor

New Pilgrim Baptist Church
Woodville, 283-7227
The Rev. James Mitchell, Pastor

New Shady Grove Baptist Church
3 m. east of Woodville, Hwy. 190, 283-2607
The Rev. Leonard White, Pastor

New Shiloh Baptist Church
West of Woodville
Louis Tubbs, Pastor

Oak Grove Baptist Church
Colmesneil, Texas
Jimmy Graham, Pastor

Palestine Baptist Church
3 miles N. of Chester on Hwy. 287
Rev. N. Joseph Jr., Pastor

Pilgrim Rest Missionary Baptist
Cobb Mill Road, Woodville
Rev. R.L. Session, Pastor

Pleasant Hill Baptist Church
401 M.L.K., Woodville 283-3008
C.O. Hudson, Pastor

Pleasant Hill Baptist Church
305 W. Bluff, Woodville, 837-2559
Russ Warner, Pastor

Rockland Baptist Church
Rev. Tom Owen, Pastor

Rocky Springs Baptist Church
Pastor

New Zion Baptist Church
Spurger; Lester Mitchell, Pastor

Spring Hill Baptist Church
Woodville, 283-5745
Pastor

South Spurger "Miracle" Baptist
Highway 92 south of Spurger, 429-5077
Webster Gilchrist, Pastor

Sunset Missionary Baptist
FM 1943, West of Dam B
Bro. John Collins, Pastor

True Vine Baptist Church
1 miles East of Doucette
A. McNeil, Pastor

Worship Chapel
E. of 92 on 1745 (Old Town Bluff)
Bro. John Spahnback, Interim Pastor

Warren Chapel Baptist Church
Warren; Mark Hadnok, Pastor

White Tail Ridge Baptist Mission
283-5938, Robert Hagrave, Pastor

Woodville Missionary Baptist
Hwy. 1746, Town Bluff Rd. 283-7983
D.L. Ross, Pastor

Christian
First Christian Church
109 Charlton, Woodville
283-2449
John Boehnke, Minister

Church of Christ
Dam B Church of Christ
15 miles E. of Woodville on Hwy. 190
283-7746, Alvin Lockie, Minister

Pine Street Church of Christ
604 Pine (Hwy. 287 & Nellius St.)
283-8328, Don L. Byler, Evangelist

Warren Church of Christ
Warren, Texas 547-2785
Jill Little, Minister

Woodville Church of Christ
Hwy. 190 West 283-5977
Eugene Greer, Minister

Church of God
White's Chapel Church of God in Christ
302 Black Gum, Woodville, 283-7095
The Rev. Lenon White, Pastor

Episcopal
St. Pauls Episcopal Church
1 mile W. of Woodville on Hwy. 190
283-3710
Rev. Nick Novak, Vicar

Inter-Denominational
His Place Family Outreach
305 W. Bluff St., Woodville 283-5888
Ron Davis, Pastor

Woodville Christian Center
203 E. Bluff, Woodville, 837-2559
Russ Warner, Pastor

Latter Day Saints
Church of Jesus Christ L.D. Saints
Hwy. 92, Fred, Texas
James Odum, Branch President

Church of Jesus Christ L.D. Saints
Pine St. Chapel, Woodville
Tim Durr, Branch President

Lutheran
Faith Lutheran Church
704 W. Holly, Woodville 283-7171
Walter P. Snyder, Minister

Methodist
Cade Memorial United Methodist
Chester, Texas
The Rev. Frank C. Cady, Pastor

Howell First Congregational
7 miles N. of Woodville, Hwy. 190
283-5070, Jesse R. McKee, Pastor

Midway United Methodist
563-2695
Bob Fosburgh, Pastor

Spurger United Methodist
Spurger, Texas
Rev. John F. Allen, Pastor

Warren United Methodist
Warren, Texas 547-2669
Rev. Bob Fosburgh, Pastor

Woodville United Methodist
Woodville, Texas
Bobbie Weber, Pastor

Non-Denominational
Christ Holy Temple
Clear Springs Community, 283-5668
D.R. Mitchell, Pastor

Christian Life Center
335 White Tail Ridge, Woodville
283-5331
Bro. Leonard Witt, Pastor

Community Church
23 FM 1746, Woodville
R.L. Sanders, Pastor 828-3646

Hampton Full Gospel Church
2 miles W. of Chester on Hwy. 287
Rev. James T. Loving, Pastor

New Creation
Hwy. 190, Timberland W. &
Old Livingston Hwy.
Arthur McInnis, Pastor

River Acres Full Gospel Church
Sheffield Ferry, Spurger
283-5351
Bro. Leonard Witt, Pastor

White Tail Ridge
White Tail Ridge west of Woodville (four miles off Highway 190)
Lonnie and Debbie Ashton, Pastors

2 1/2 miles N. of Woodville on Hwy. 69
283-2156, David Emmons, Pastor

Pentecostal
First Pentecostal Church of Fred
Fred, Texas
Jerry Peck, Pastor

Pleasant Valley Pentecostal
Highway 287, Chester, Texas
Jesse LeBlanc, Pastor

Spurger United Pentecostal
Spurger, Texas
Thomas Hall, Pastor

The First Church of Jesus Christ
Fred, Texas
S.E. Knighton, Pastor

Warren United Pentecostal
Warren, Texas
Richard Penny, Pastor

Woodville United Pentecostal
West Bluff, Woodville
R.L. Mageeche, Pastor

July 6

WEDNESDAY
July 6, 1994

Volume 66 Number 27
WOODVILLE, TEXAS
25 CENTS
USPS 645-560

THIS WEEK

Wednesday, July 6
Woodville Rotary Club meets at noon in the Woodville Inn.

Thursday, July 7
Woodville Lions Club meets at noon in the Lions Den on US 190. Eat!

Friday, July 8
The Tyler County Golf Retirees' Club will meet at 5 p.m. at the Club in Jasper.

Saturday, July 9

A reunion of the Kirby High School Class of 1959 will be held today at the Woodville Inn. A hospitality period will be from 6-8 p.m., and a meal will be served at 8 p.m.

The monthly gospel signing program hosted by the Oak Grove Baptist Church on RR 255 near Colmesneil will resume today at 7 p.m. Lloyd Durham, Shirley Walker and Dr. Hope Baptist Church choir will be featured.

Sunday, July 10
The Emmanuel Baptist Church will observe its 50th anniversary during the morning worship service. A lady also will be celebrated during the morning worship service. Singing will be a feature and a special singing at the afternoon church is planned for 10 a.m. at 1943 West of Doucette on Highway 69.

Monday, July 11

The Heritage Village Players will meet at 3 p.m. at the Ham House at Heritage Village, located just west of Woodville off Highway 190. Anyone interested in working with the drama group is invited.

A gospel meeting will be hosted by the Church of Christ at Dam B today through Friday, July 15, beginning at 7:30 p.m. Gene Sanford of Rosenberg will be the preacher.

Tuesday, July 12

A summer blood drive will be held from 10 a.m. to 1 p.m. and from 2-5:30 p.m. at the Woodville United Methodist Church by the Blood Center of Southeast Texas.

All area senior citizens are invited to the regular meeting of the Woodville Chapter No. 792 of the American Association of Retired Persons (AARP) to be held at 10:30 a.m. today at the Woodville Lions Den, located off Highway 190 East.

Wednesday, July 13

The Woodville City Council meets at 7 p.m. in the City Hall.

Thursday, July 14
The Tyler County Commissioners Court meets at 10 a.m. in the Tyler County Courthouse in Woodville.

All area senior citizens are invited to the regular meeting of the Woodville Chapter No. 792 of the American Association of Retired Persons (AARP) to be held at 10:30 a.m. today at the Woodville Lions Den, located off Highway 190 East.

The Tyler County Booster

Serving the people of Tyler County since 1930

New heroes, definitions needed

-Hightower calls for changes during Fourth of July rally-

By Greg Peak
Editor

COLMESNEIL — Citing problems crime and the break down of the family structure, State Rep. Allen Hightower called for changes in the way people select their heroes and a new definition for success.

"We and we alone have caused the problems we now have and we must be the ones who solve them," he told the group.

"The celebration, which included both a Christian and a patriotic theme, is a salute to the United States on its Independence Day holiday. Hosted by the Mt. Carmel Baptist Church, it is sponsored by Colmesneil area churches, street by street, house by house effort to change the way we view the world.

"We have alone caused the problems we now have and we must be the ones who solve them," he told the group.

"The celebration, which included both a Christian and a patriotic theme, is a salute to the United States on its Independence Day holiday. Hosted by the Mt. Carmel Baptist Church, it is sponsored by Colmesneil area churches, street by street, house by house effort to change the way we view the world.

"We have alone caused the problems we now have and we must be the ones who solve them," he told the group.

"The celebration, which included both a Christian and a patriotic theme, is a salute to the United States on its Independence Day holiday. Hosted by the Mt. Carmel Baptist Church, it is sponsored by Colmesneil area churches, street by street, house by house effort to change the way we view the world.

"We have alone caused the problems we now have and we must be the ones who solve them," he told the group.



GOD AND COUNTRY — State Rep. Allen Hightower of Huntsville was the guest speaker Monday during the Fourth Annual July 4 God and Country Celebration held at the Mt. Carmel Baptist Church near Colmesneil. The rally was sponsored by the Colmesneil area churches as a patriotic and spiritual tribute to God and the United States. (Photo by Greg Peak)

Alabama-Coushatta dancers perform at Goodwill Games

INDIANVILLE — The Alabama-Coushatta Tribes of Texas have been selected to perform dancers and drummers to perform in the prestigious opening ceremonies of the 1994 Goodwill Games in Kirov Stadium, St. Petersburg, Russia, on July 23.

The group, which will be the official representatives of Native Americans at the athletic event, will leave on July 16 for Russia and will have the opportunity to visit such places as the Summer Palace, attend a ballet and circus and a Hydrofoil Cruise.

The performance by the Alabama-Coushatta Tribal Dancers will be the first of its kind and will be the only time that the Alabama-Coushatta tribes will participate in a worldwide television audience of tens of millions plus a capacity crowd of 70,000 in the stadium.

The event will provide participants with a "most exhilarating experience" and concurrently the Alabama-Coushatta tribes will have the opportunity to promote the state of Texas and its rich history and traditions.

The tribal dancers are based at the Alabama-Coushatta Reservation, located between Woodville and Livingston on Highway 190.

'Freedom Forever' crusade is expression by teenagers

WOODVILLE — Organizers of the Christian "Freedom Forever" Youth Crusade and Concert" say the event to be held at 8 p.m. Friday in Woodville will be a huge expression of Tyler County teenagers "having fun doing the name of Jesus."

The concert will be held at the Dogwood Amphitheater behind the Woodville Elementary School.

"We're going to try to show the gospel being presented in a fun way. We will show that you can have fun with the name of Jesus," said Woodville's Craig Larson.

"It will be a spiritually charged-up event with the power of the Spirit," Larson said, adding, "Our vision is to reach the lost teenagers of Tyler County with the gospel of Jesus Christ in a fun way, so they can be brought into the Kingdom of God and have a weapon in the hands of God. We're trying to get the flock turned over to the Shepherd."

"Everyone is welcome, no matter what age," says Craig Larson.

"God has called Craig to preach at this event," said Hillary Fortenberry, a co-organizer and the treasurer for behind the finances of the event.

"We're going to show people the fun in knowing Jesus, especially the lost teenagers of Tyler County," said Larson.

Along with Larson and Fortenberry, Christian comedian Chris Lacus will bring his gift of humor in presenting the gospel in a fun way. He will give his testimony through his comedy act.

The group is also made up of Dale

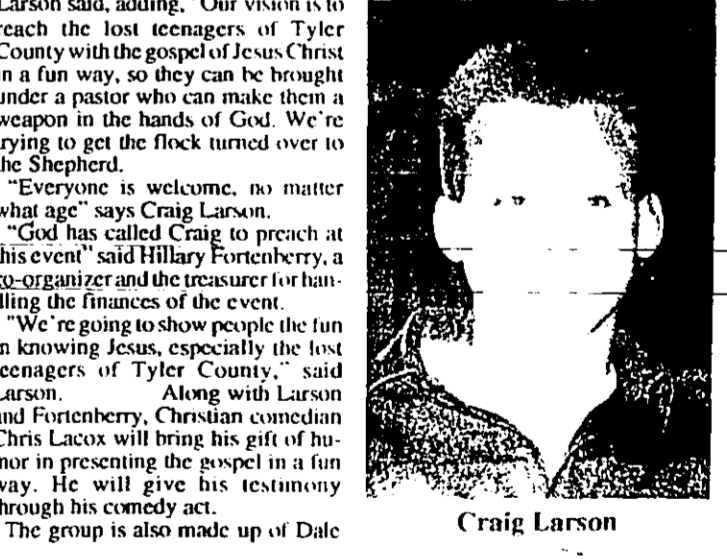

Warren man killed in one-car mishap

KOUNTZE — A 40-year-old Warren man was killed last week after apparently falling asleep at the wheel of his truck before it tumbled into a drainage culvert on Highway 69 north of Doucette.

Roger William Ray was pronounced dead at the scene of the accident about 5:40 p.m. Thursday, June 30.

According to Department of Public Safety accident reports, his 1990 Ford pickup swerved out of the northbound lane of Highway 69. It is believed that Ray had fallen asleep and that his truck left the road, he swivle and tried to hit his brakes before the pickup slammed into the culvert.

Funeral services for Ray were held at 2 p.m. Saturday, July 2, from the Stranger and Griffin Funeral Home in Woodville with burial following in the Warren Cemetery in Woodville.

A lifetime resident of Warren, he was an operator with DuPont in Warren and was a member of the Warren United Methodist Church and the Warren Mason Lodge No. 658.

Survivors included two sons, Eric Ray and Justin Ray, both of Warren; his parents, I.W. and Cecil Ruth Ray of Warren; his grandmother, Mrs. D. Ray of Beaumont; two brothers, Curtis D. Ray of Houston and James Curtis Ray of Warren; a sister, Sheron Ray Gulley of Warren; and two nephews.

Church News

Revival slated in Town Bluff
TOWN BLUFF — Revival services will be held Wednesday, July 6, through Sunday, July 10, at the Victory Baptist Church located on FM 1746 near Town Bluff.

Morning services will be held from 11 a.m. to noon with night services from 7 p.m. to 10 p.m.

Pastor Wallace Edgar will be the evangelist and Chuck Gulbert will be the singer. Both are from the Trinity Baptist Church of Texarkana, Texas.

'John Wayne' speaker to appear
JASPER — Dr. Gene Howard, an internationally known John Wayne impersonator, will present several poems from his album "What Made America Great" during an appearance set for 11 a.m. Sunday, July 3, at the Ebenezer Baptist Church near Jasper.

Howard will bring a patriotic and spiritual message entitled "Freedom and Sacrifice" in full, old-time cowboy regalia. Those attending are invited to bring cameras to have their pictures taken with Howard.

Sawmill ghost towns subject of new book

LUFKIN — A limited edition history of sawmill and sawmill towns in eight East Texas counties, the result of research by Nederland historian W.T. Block, will be published this fall by the Pineywoods Foundation.

"East Texas Mill Towns and Ghost Towns," the first of three volumes on East Texas sawmill towns written by Block, will include Angellina, Chambers, Jefferson, Nacogdoches, Newton, Orange, Polk and Tyler counties.

"For years, W.T. Block has spent most of his waking hours visiting old sawmill sites, talking with those who lived and worked there and combing through thousands of documents. He put together the most comprehensive anthology of sawmill towns and ghost towns ever assembled in East Texas," said John Anderson of Nacogdoches, chairman of the Foundation.

Block has published two previous books, "A History of Jefferson County, Texas: From Wilderness to Reconstruction" and "Sapphire City of the Neches: A History of Fort Neches, Texas."

He retired from the U.S. Postal Service after 25 years, including 20 as assistant postmaster at Nederland and as officer-in-charge of the Orange post office. He is also retired from 10 years as postal director at Lamar University, where he received his BA degree in history in 1970 and his MA degree in 1974.

Hundreds of sawmill towns prospered in East Texas during lumbering's golden era between the 1850s and 1920s. But when the timber played out, many of the sawmills killed their towns and moved on, leaving behind overgrown forests, clusters of clapboard buildings, and remnants of concrete and steel.

Some of the sawmills and towns, however, overcame adversity by replanting their forests and diversifying their produce lines. They continue to be viable in the pineywoods today, supported by modern sawmills or other wood-using plants, as well as new forms of economic activity.

A World War II veteran and former U.S. Postal Service employee, Block has published two previous books, "A History of Jefferson County, Texas: From Wilderness to Reconstruction" and "Sapphire City of the Neches: A History of Fort Neches, Texas."

He retired from the U.S. Postal Service after 25 years, including 20 as assistant postmaster at Nederland and as officer-in-charge of the Orange post office. He is also retired from 10 years as postal director at Lamar University, where he received his BA degree in history in 1970 and his MA degree in 1974.

Disabled children may benefit from SSI

LUFKIN — The SSI program provides monthly benefits to more than a half million low-income children under age 18 who are blind or have disabilities. These children may qualify for disability benefits under SSI even if their parents do not. The children must meet Social Security's definition of disability or blindness in addition to meeting income, resource, and other eligibility requirements.

Children who have disabilities may now receive higher Supplemental Security Income (SSI) benefits as a result of a recent change in the way Social Security computes the effect of their parents' income on their payments.

For a child who is under 18, unmarried, and living with parents, Social Security may count some of the parents' income and resources as the child's. This process is called deeming.

Under the new rule, Social Security will use a single formula to calculate how much of the parents' income is deemed to the child, whether the income is earned, unearned, or a combination of the two. The new rule applies only when one or both parents are working.

Two groups of children are encouraged to contact Social Security to see if the new rule affects their eligibility: (1) children whose applications for SSI benefits were filed before Nov. 1992 and who were denied benefits based on their parents' income and (2) children for whom no application was filed because they believed their parents' income would make them ineligible.

To find out more about the new rule, or to obtain information about SSI for children, call Social Security's toll free number, 1-800-772-1213.

'God and Country Day'
First Baptist Church, 205 W. Wheat, Woodville
Sunday, July 3, 1994
9:15 a.m. Bible Study
10 a.m. Worship
-Color Guard-
-Patriotic Music-
Recognition of those who have served in the armed forces. Wear uniform if possible.
Message by Pastor Chet Hany:
"Stars and Stripes Forever"

Nita's Fashion Located at: The Woodville Inn Saturdays only 283-3741 or 283-2877	E & L Lumber Co. WOODVILLE, TEXAS 283-2622 Woodville, Tx.	FEW READY MIX 283-2622 Woodville, Tx.	Woodville Compulsent Center Living with dignity, Aging with understanding. Caring with pride. 102 N. Beech - 283-2534 - Woodville
KNAPP Corner of Hwy. 283-2526	FORD 283-2526	Member FDIC	Jarrott's Pharmacy "Serving Tyler County Since 1952" 205 S. Magnolia - 283-2550 - Woodville
Food Market 647-3338	WOULD YOU LIKE TO ADVERTISE HERE? CALL 283-2516	Bookshire Books "The Best For Less" - 283-3333, Woodville, Texas	WOULD YOU LIKE TO ADVERTISE HERE? CALL 283-2516
DOGWOOD TRAILS MANE 76 Hwy. 193 West - 283-6147 - Woodville	Allison Chevrolet Hwy. 69 in Chester - 283-7865	Bestway Foods	FIRST National Bank WOODVILLE BRANCH Your Full Service - Full Trust Bank 283-6231 - Hwy. 190 E. - Woodville
WAL-MART 1747 Hwy. 69 - Woodville - 283-3244	McDonald's of Woodville "We have Pizza & Pasta" 283-5855	BOOSTER	TEMPLE-INLAND FIREST PRODUCTS CORPORATION

Sports

with Don Stevenson

Colmesneil trio named to all-state team

COLMESNEIL — Three members of the Colmesneil High School baseball team have been named to the Class A all-state team by the Texas Sports Writers Association.

According to the list released Monday, Bulldog senior pitcher **Bucky Allen** was named to the all-state first team while senior catcher **Jeff Allen** and senior shortstop **Kevin McQueen** were selected for second team honors.

The only Class A team to place more players on the all-state roster was Trinidad, which defeated Colmesneil 6-4 in the state quarter finals and then went on to state finals where they fell to Gunter. The Trojans had five first team selections, including sophomore first baseman-pitcher **Robby White** as player of the year and Coach of the Year **Charles Wigley**.

White also was named to the first team roster with both the pitcher and first baseman positions.

Gunter, which won the state title, also placed three on the all-state list, including two first team and one second team selection. State semi-final qualifier **Gorman** had one second team and one third team selection while the other semi-finalist, **D'Anis** had one player named to the third team.

Following is the complete listing of the Class A picks for 1994:

FIRST TEAM
Pitchers: Don Meranda, Gunter, junior; Bucky Allen, Colmesneil, senior; Robby White, Trinidad, sophomore.
Catcher: Chad Devivo, Liga, senior.
First Baseman: Robby White, Trinidad, sophomore.
Second Baseman: Rick Quantebaum, Covington, senior.
Shortstop: Jay Mason, Trinidad, senior.
Third Baseman: Dale Burk, LaPorton, junior.
Outfielders: Cody Bonds, Gunter, senior; Alas Hul, Granger, junior; Jeff Williams, sophomore.

SECOND TEAM
Pitchers: Don Meranda, Gunter, junior; Bucky Allen, Colmesneil, senior; Robby White, Trinidad, sophomore.
Catcher: Chad Devivo, Liga, senior.
First Baseman: Robby White, Trinidad, sophomore.
Second Baseman: Rick Quantebaum, Covington, senior.
Shortstop: Jay Mason, Trinidad, senior.
Third Baseman: Dale Burk, LaPorton, junior.
Outfielders: Cody Bonds, Gunter, senior; Alas Hul, Granger, junior; Jeff Williams, sophomore.

National all-stars to play Saturday

WOODVILLE — Tyler County's National Little League All-Stars will play Kirbyville Saturday in second round action of the District 12 Little League Baseball Tournament.

The National League All-Stars advanced to second round play by defeating Anaheim last week, 11-8, at Hennigan Park.

Catcher **John Moore** and centerfielder **Matt Dees** led the local all-stars with three hits each. Both had doubles, along with third baseman **Jared Odom**. First baseman **Blake Belt** rapped out two hits in the game.

Roderic Douglas was the winning pitcher in the bottom of the third with only six hits, struck out 14, and walked five in going the distance.

Tyler County opened the game with a solo run in the first inning, but Anaheim came back to beat 2-1 on a pair of runs in the top of the third.

The local all-stars went back ahead in the bottom of the third with three runs, but Anaheim tied it in the top of the fourth with two more.

Tyler County finally put the game

Junior League All-Stars Baseball Tournament

GAMES START AT 7 P.M. UNLESS FIELD DOUBLEHEADER * = HOST PARK

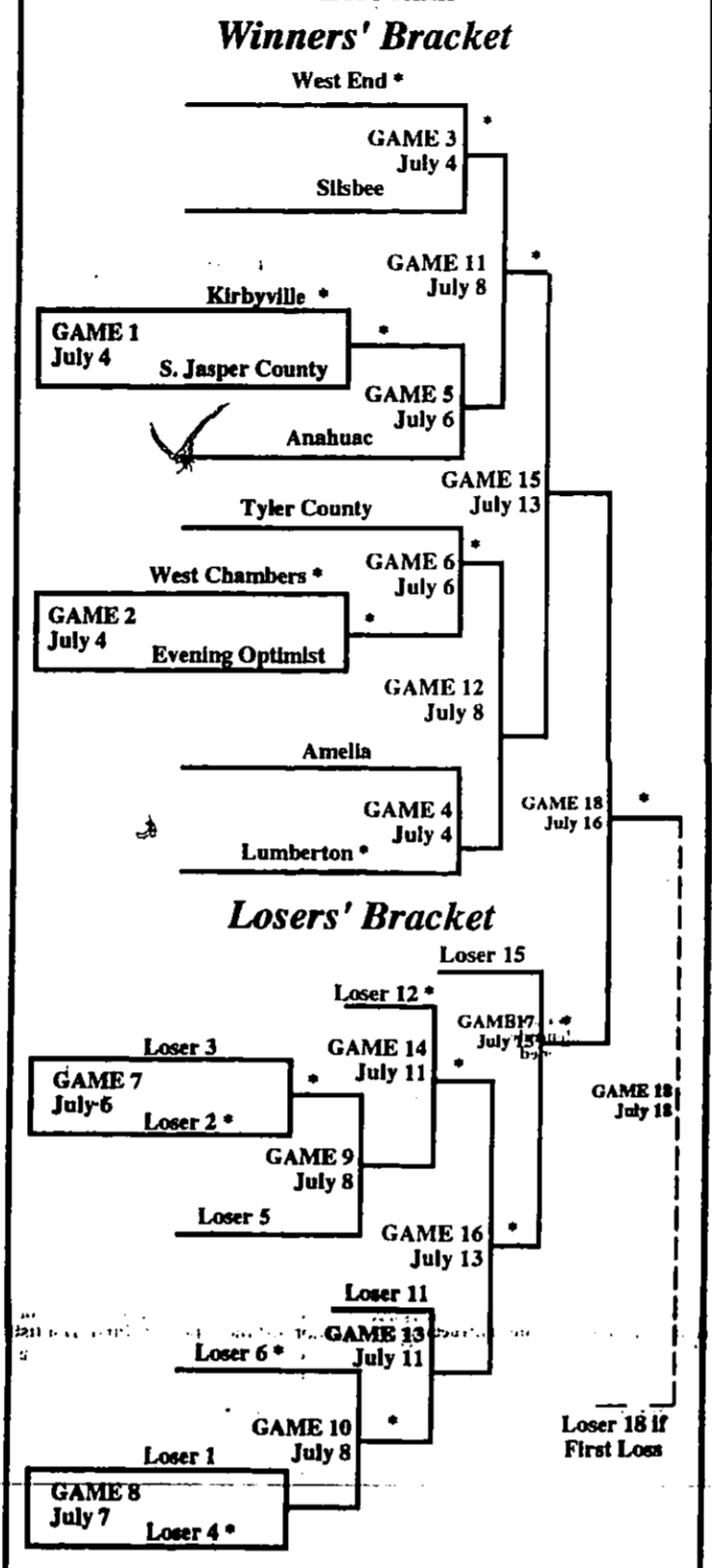

LANDOWNERS OBJECT TO SEWER PLANT LOCATION — Virginia Baker (right) of Woodville is shown following a special Woodville City Council meeting held Monday, June 27, in discussion with Councilman W.S. Nichols, D.V.M. (left). Baker, along with 12 other concerned citizens, brought objections to the proposed location near their homes on the Seneca Loop Road, of a 250-acre, 3-million-gallon per day capacity recycled sewer filtration plant. The item has been placed on the next Woodville City Council meeting agenda for Monday, July 11, beginning at 7 p.m. (Photo by John Morrison)

Minor softballers win district title

TYLER COUNTY — Tyler County's Minor League Softball All-Stars blew past Kirbyville twice last week to take the district title and advance on to sectional play.

The local all-stars smashed Kirbyville 30-0 in second round play, and came back to defeat Kirbyville again, 15-4, in the championship.

The Tyler County All-Stars will now be advanced to the sectional tournament to be held in Sweeny July 20.

Jessy Davis stopped Kirbyville in the championship with a six hit pitching performance. She also had a triple

	B	R	E	R
Kirbyville	0	0	0	0
Tyler County	8	7	15	8
Winning Pitcher - Kaci Andrus				

Minor League all-stars eliminated

TYLER COUNTY — Both of Tyler County's Minor League All-Stars were eliminated from tournament play last week after losses to Beaumont's West End.

The American League All-Stars fell to West End, 10-2, on a no-hitter. The National League All-Stars defeated South Park 9-7 in extra innings before falling to West End 7-4.

Softball major all-stars win

LUMBERTON — Tyler County's Major League All-Stars blasted Lumberton 20-7 in the opening round of district tournament play Saturday night to advance to second round action against Beaumont's West End Thursday.

The county banged out 21 hits in the four inning contest. Miranda Cheney led with way with two doubles and a single. Katrina Corn and Daniels each had a triple and two singles. Ashley Flowers had a double and two singles, while Kelly Gallagher and Bridgette Snider each had a double.

Part-Time Licensed Beautician needed for long term care facility. If interested, apply in person at **Dogwood Trails Manor** 76 Hwy 190 West, Woodville

ALLISON CHEVROLET, INC.

USED CARS
'93 Buick Century 4 Dr. • Loaded, Like New. \$12,000+
'96 Chevrolet Caprice 4 Dr. • Good Condition. \$3500+
'85 Volvo Station Wagon • Clean, Leather Seats. \$4500+

USED TRUCKS
'93 Chevrolet 1/2 Ton Pickup • Nice, Low Miles. \$12,500+
'93 3/4 Ton Pickup • Super Nice, Low Miles. \$12,000+
'92 GMC 1/2 Ton Pickup • Low Mileage. \$10,500+
'92 Chevrolet Extended Cab • Exc. Condition. \$11,000+
'91 Chevrolet 3/4 Ton Pickup • Nice, Low Miles. \$9700+
'91 Chevrolet 610 Extended Cab • Nice, Low Miles. \$7600+

Hony • 69 • Colmesneil • 287 7605 • 277 2244

Allen hurls senior all-stars to victory

WOODVILLE — Kemece Allen struck out 11 and allowed only one hit in pitching the way to a 16-5 win by the Tyler County Senior League Softball All-Stars over Lumberton Monday night.

While Allen took care of the mound work, Eryn Byron blasted a third inning home run and added a double in driving in five of Tyler County's 16 runs.

Other top hitters included Amanda

13-year old all-stars begin play

TYLER COUNTY — Tyler County's 13-Year Old All-Stars are set to travel to West Chambers Wednesday night in first round action of the District 12 Baseball Tournament.

A win by the local all-stars would

Kickoff Classic set for July 16

WOODVILLE — The Second Annual Kickoff Classic Golf Tournament sponsored by the Woodville Athletic Booster Council will tee off on July 16 at the Dogwood Hills Country Club in Woodville.

The event will be a four-man Florida scramble event with registration set at \$35 per player. Players may register as a single or may form their own teams.

Registration is limited to the first 36 teams, with the entry deadline set for July 13.

For more information, call 283-8725.

2nd Annual Kickoff Classic Golf Tournament

Saturday, July 16th
DOGWOOD HILLS COUNTRY CLUB
4-Man Florida Scramble
\$35 Per Person-carts included
Team Trophies, Door Prizes, Hole Prizes, Putting Contest For TV, Lunch Provided.
Form your own team or sign up single.
No limit on handicaps
Limited to the first 36 teams. Deadline for entry Wednesday, July 13. AM & PM Tee Times. Call 409-283-8725.
All proceeds to benefit: WOODVILLE ATHLETIC BOOSTER COUNCIL

\$25 gets you the most affordable personal checking account in the Community.

Fill Out This Entry Blank and mail to address below:

Name: _____
Address: _____
City: _____ St. Zip: _____
Phone: _____

Clip & Mail To: Kickoff Classic Tournament Chairman, c/o Dogwood Hills Country Club, 150 Hwy 190 West, Woodville, Tx 75778

CDS 5.50%

MONTHLY INTEREST Minimum deposit may be required. F.D.I.C. INSURED!

Call **Cam Monroe** (409)384-5715 (800)696-3782

Advanced Financial Services

102 W. Water St. Jasper, TX. 75951

Bertie Sewell Ambrose

DOUCETTE — Services for Bertie Sewell Ambrose, 84, of Doucette who resided in Doucette for 32 years. She was a member of the Doucette First Baptist Church where she served as a nursery attendant and Bible school workers. Mrs. Ambrose expressed desire in having received a birthday card from President Bill Clinton on her 84th birthday.

Survivors include two daughters, Sally Tucker of Doucette and Janette Williams of Houston; three sons, Johnnie L. Ambrose of Village Mills, H.J. Sewell of Bedford and Doyle L. Ambrose of Texas; 16 grandchildren; and 25 great-grandchildren.

Palbearers were Ben Irish, Randall Ambrose, Tim Ambrose, Chris Ambrose, Ricky Ambrose, Francis Irish and Cody Tucker.

Riley Funeral Home of Woodville directed the arrangements.

Spring Sale

1 Pair Soft Contact Lenses \$119.00
4 Pair Disposable Contact Lenses \$165.00

*Exam Not Included
*Extra Charge for Toric Lenses

Single Vision Glasses
1 Pair \$49.00
2 Pair \$79.00

Bifocal Glasses
1 Pair \$69.00
2 Pair \$99.00

FRAMES INCLUDED
Exam, Prescription Required

SAME PRESCRIPTION SPECIALS TAGGED FRAMES Offer includes most single vision and bifocal prescriptions. Some lens restrictions apply. Toric, UV, and No Scratch treatments are available at regular cost. Complete glasses include frames and lenses. No other discounts apply.

NO COUPON REQUIRED

Dr. Gary E. Tatum
Optometrist
103 N. Pecan, Woodville 283-3011

Spring Sale

Dr. Gary Tatum

Rayburn Country GOLF SPECIALS!

27 Holes w/Cart Mon. & Thurs. \$32.50 + tax, per player
18 Holes w/Cart Tues. & Wed. after 1 p.m. \$22.50 + tax, per player
9 Holes w/Cart-Tuesday Special Mon. thru Thurs. after 5 p.m. \$12.50 + tax, per player

Call 1-800-882-1442

We Beat Out-Of-Town Prices!

NEW '94 Pontiac Sunbird LE
4 Dr. stk. #2382

*\$11,718

NEW '94 Pontiac Firebird
stk. #2337

NEW '94 BUICK SKYLARK 4 DR. - #2346 - \$14,278 + tax - Automatic, A/C, DeFogger, Cruise, Tilt, Aluminum Wheels, AM/FM Cassette, Anti-Lock Brakes, & More.

NEW '94 BUICK CENTURY 4 DR. - #2350 - \$15,195 + tax - Power Windows, Auto. Door Locks, Trunk Release, Rear DeFogger, Cruise, Tilt, AM/FM Cassette, Driver Air Bag, & more.

NEW '94 BUICK CENTURY 4 DR. - #2225 - \$14,906 + tax - Automatic Door Locks, Driver Air Bag, 3100 V6, Automatic Transmission & More.

A&M Motor Co., Inc.
Pontiac • Buick • Oldsmobile • GMC Trucks
605 S. Magnolia 283-2534

Rayburn Country
GOLF SPECIALS!
27 Holes w/Cart
18 Holes w/Cart
9 Holes w/Cart-Tuesday Special

DOGWOOD TRAILS MANOR
Tyler County's Newest Nursing Facility
76 Hwy 190 W. Woodville, TX 75799
409-283-8147

Business and Service Guide

STOP

You haven't tried everything until you've tried gentle CHIROPRACTIC CARE For your head and body aches and pains.

TYLER COUNTY CHIROPRACTIC
Call for an appointment 283-0133
Dr. Stephen P. Porsait

RENT A TEMPO
from KNAPP FORD for only \$20 per day and 20¢ per mile 283-2526

Would you like to advertise here?
Economical & Effective...
Call 283-2516.

TRIPLE "L" EQUIPMENT RENTAL
SALES & RENTALS
AIR COMPRESSORS
POWER TOOLS
CONCRETE MASONRY
ELECTRIC AIR COMPRESSOR & TOOLS
PUMPS & GENERATORS
HIGH PRESSURE WASHERS
PORTABLE WELDERS
SANDBLASTERS & POST HOLOGRAPHERS
DIRT ASPHALT COMPACTOR
TRENCHERS
ROTARY TILLERS
PAVING BREAKERS
CONCRETE CURERS
384-8917
605 E. Milan Jasper

Summer Clearance!!!



MANN FURNITURE

beginning at \$87.50 each piece

Twin - in sets. (While supplies last)

206 W. Bluff (On Courthouse Square) 283-3740
 1123 S. Magnolia (Next to WalMart) 283-8286

Introducing the most beautiful liquid MAKEUP under the sun.

MERLE NORMAN COSMETIC STUDIOS

The place for the beautiful place. Merle Norman's new Liquid Makeup with sunscreen protection already in it! It's one of our brightest ideas, thanks to SPF 16, the lightweight coverage it gives you, and the moisturizers that are also in this great new foundation. So come into your nearest Merle Norman Cosmetic Studio and have your day in the sun.

312 W. Bluff 283-8386



FRED GROCERY
KEITH HATTON

WATERMELONS! Red & Yellow

12-Pack COKE & DR. PEPPER \$2.89

Other great buys on Lunch Meat, Ice, fresh vegies, Charcoal & More!

HWY. 92 in FRED, TX. 429-3993

'94 FORD CROWN VICTORIA \$17,995



KNAPP FORD

V8 Automatic, Clearcoat Paint, Speed Control, Dual Air Bags, Power Door Locks, Air Conditioner, WSW Tires, AM/FM Stereo, Power Windows, Rear Window DeFroster, Split Bench Seat, Tilt Steering Wheel, Four Wheel Power Disc Brakes, Interval Wipers.

CORNER HWYS. 69&287 283-2526

WANT TO BUY PINE & HARDWOOD

Woodville • (409) 283-2025



Kirby Forest Industries

UP Louisiana-Pacific
Helping the forest work for people

Tyler County's **Business Of The Week**

THE MUFFLER SHOP

For all your Muffler & Radiator Repairs



•Cars & Trucks
•Domestic & Foreign
•Custom Dual Exhaust
•Custom Pipe Bending

4020 Hwy. 69 S. 283-5502
(Between Dale's Trailer & Jimmy's Burgers)

LAWN-BOY

Rated "Best Buy" Two Years In A Row.



TIMBERMAN'S SUPPLY

*Rated "Best Buy" in 1993 and again in 1994!
 *Dependable 4.5 HP commercial grade 2-cyle engine.
 *Easy Mulch cutting system mulches even thick, heavy grass.
 *Lightweight, stagered wheel deck for easy handling and close trimming.
 *And at only \$269, this "Best Buy" is also a Best Value!

\$269.
Silver Series Model #10201 4.5 HP Lawnmower

213 E. Bluff 283-8118

THE MUFFLER SHOP

UNDER NEW OWNERSHIP

For all your Muffler & Radiator Repairs

•Cars & Trucks
•Domestic & Foreign
•Custom Dual Exhaust
•Custom Pipe Bending

4020 Hwy. 69 S. 283-5502
(Between Dale's Trailer & Jimmy's Burgers)

DAIRY QUEEN

Plate Lunches \$4.95

Offered Daily at S. Magnolia Dairy Queen. Dinner includes: Choice of Meat, salad, 3 Vegetables, Roll or Cornbread & Dessert EVERYTHING MADE FROM SCRATCH!

Senior Citizens: \$3.95 includes Meat, salad, 2 Vegetables, Roll or Cornbread & Dessert

1308 W. BLUFF 283-2584
1009 S. MAGNOLIA 283-2584

T&M JEWELRY REPAIR

GRAND OPENING JULY 14

OPENING FOR BUSINESS SATURDAY, JULY 9

•Jewelry Repair
•Custom Design •Stone Setting

Christopher Tubb/Noel Monzingo

108 N. CHARLTON 283-6848

DOGWOOD TRAILS MANOR



Helen Hotchkin, new Activities Director at Dogwood Trails is also new to the Tyler County area. She and her fiancé are building a home near the Indian Reservation and she is excited about living "in the county again" and working with the Dogwood Trails residents & also the community. "One of the things that attracted me to this nursing facility is how involved the residents are in the goings of Tyler County. I hope to continue the tradition & I look forward to meeting everyone." Come see the difference caring makes.

76, Hwy. 190 West 283-8147

1. GARAGE SALES

Small Garage Sale - Thursday through Saturday, July 7, 8, and 9. Sewing machine, brooms, household items, baby clothes, computer bow, and lots more. About one mile south of Warren, off Highway 69, follow signs. 27-1b

Garage Sale - Friday and Saturday, July 8 and 9. 9 sleeper sofa, regular sofa, a lot of nice items. Children's Movement Works, Highway 69, four miles south of Woodville. 27-1b

2 Family Garage Sale - Saturday, July 2, from 8 a.m. to 4 p.m. Bakrod Sparger Post Office on Highway 92. 27-1b

Garage Sale - (Hill Storage Sale) Saturday, July 2, from 9 a.m. to 2 p.m. Cobb Mill Road, follow signs. 27-1b

4H. PAINTING

PAINTING - Quality interior work, no job too small. Reasonable prices, free estimates. Call Frank Services at 837-2581. 24-10c

4I. PLUMBING

C & C Plumbing Co.

283-2228

283-2228

2D. NUTRITION/WEIGHT LOSS

DIET PLUS

A SAFE WEIGHT LOSS PROGRAM. WITHOUT THE CHEMICALS. LOSE WEIGHT AND FEEL BETTER IN 30 DAYS. OR YOUR MONEY BACK. ASK FOR SAMPLES.

283-2448 ASK FOR LOIS 27-4c

3L. YARD CARE

Hard working young men wants to do yard work in the Ft. Worth area. Four years' experience, reasonable rates. 283-3464. 17-4b

Will do odd jobs and yard work in the Woodville area. Responsible teenager, age 15. Call 283-7290. 23-2b

4K. STORAGE FACILITIES

TEJAS MINI-STORAGE

Store with Friends

1099 256 East Commercial 21-4b

409-837-9704 or 837-9409 21-4b

4C. CONSTRUCTION/REMODELING

E & H ROOFING & PAINTING

Interior/Exterior painting, roof replaced/ repaired, pressure wash, window cleaning. Free estimate. Experienced. Work guaranteed. 283-8339. 25-4p

4N. WATER WELL SERVICE

TRI-COUNTY WATER WELL DRILLING and Service Company, 240 Pan American Dr. (Opp. St. Paul's) Wichita Falls, Livingston, TX 699-327-1214. License No. 1839 W.P. 21-4b

5. ANNOUNCEMENTS

NARCOTICS ANONYMOUS

meets Fridays, 8 p.m. - 9 p.m., St. Paul's Episcopal Church Hwy 190 West • Woodville for information call: 283-8947 or 283-3111 13-4b

AA Woodville meets each Monday and Thursday, and Saturday at 8 p.m., at St. Paul's Episcopal Church. For more information call 283-5651. 25-4b

9A. JOBS AVAILABLE

YOU CAN KEEP AMERICA WORKING - SAVE JOBS

American Manufacturers - Factory Direct - for Directory send \$4.00 to: M & M Enterprises • P.O. Box 2222 Livingston, TX 77351 27-4b

Will trade oil trailer and utilities for yardwork. Must have other income. Call 837-9802 for information. 22-4b

Wanted: Venting Attendant, part time, 25-30 hours per week. Must have other income. Barry Brown at 409-634-7211. 25-4b

Accepting applications for production support positions. Starting wage \$6.00 per hour. Apply in person at Paperforest Corp., 26-3b

WANTED: EXPERIENCED bed driver for many family owned fleets. Required: At least 25 years of exp. Clean driving record. Must own car, 17, physical and drug screen. Good employment history, CDL with least 3 years exp. in truck and flat bed driving. Must be neat in appearance. Benefits: Starting pay of 22-25 cents per mile based on experience. Paid Vacation. Home weekly. Please call Clark Ogden at 409-250-1200 or 409-250-1201. 26-4b

SECURITY FINANCE CORP.

Loans from \$100 to \$396

Woodville, Warren, Chester, Colman, Houston, Coahoma, Spurger, Oleno & Rockdale

VACATION LOANS

WE LOVE TO SAY YES!

• Phone applications welcome
• Credit-Start Loans

112 W. Bluff 283-2576

Job Opportunity

DIESEL-MECHANIC/SHOP FOREMAN

Pride Pipeline Co., a fast growing crude oil trucking company in East Texas is looking for an experienced Diesel Mechanic/Shop Foreman. Must be willing to live in the Jasper, Texas area. Must have own tools. Must be good with paperwork and inventories. Excellent salary and benefits.

CALL (409)384-3368. EEO/AA

No train. No Gain.

Without advanced training, it's hard to really succeed in today's job market. The Job Training Partnership Act (JTPA) could help by providing the training required in today's competitive workforce. JTPA can provide technical/vocational training (to qualifying individuals) in areas such as:

Dental Hygienist
Dental Assistant
Computer Operator
Data Processing Equipment Operator
Auto Mechanic
Diesel Mechanic
Auto Body Repair
Secretary
Mechanical Engineering Technician
Medical Records Technician
Computer Maintenance
Accounting Clerk
Welding

Records Management
Industrial Maintenance Mechanic
Plant System Operator
Electric Power Distributor
Industrial Machine Mechanic
Truck Driver
Operator
Mechanical Engineering Technology
Medical Records Technician
Computer Maintenance
Accounting Clerk
Welding

For more information contact:
D.E.T.C.O.G., 914 Magnolia, Woodville, Texas 75797, (409)283-3795
(Areas of training subject to change. Rules and requirements of the Job Training Partnership Act apply.)

9A. JOBS AVAILABLE 9A. JOBS AVAILABLE 9A. JOBS AVAILABLE

Keller Aluminum Products of Texas

has openings on the

First Shift: Five 8-hr shifts 7 a.m. - 3:30 p.m.

Second Shift: Five 8-hr shifts 4 p.m. - 12:30 a.m.

Any persons interested in applying may do so on Mondays at 9 a.m.

Keller Aluminum
Box 709 Woodville, Texas 75797

All applicants must pass an alcohol and drug screen.

The Tyler County **Booster**

Serving the people of Tyler County since 1930

Classified Ads
Get Results

9A. JOBS AVAILABLE

Providers needed immediately in the Woodville and Chester areas. 283-7237. 27-1b

POSTAL JOBS

Start \$11.41/hr. For exam and application info. call (214) 799-5011, ext. 1283, 8 a.m. - 8 p.m., Sun-Fri. 26-4p

WANTED - Live-in elderly lady, night housekeeping and prepare meals, five days a week. Call 283-2167. 27-1b

MANN FURNITURE & APPLIANCE

Refrigerators! Incredible Deals!!

NO FROST, Top Mount Refrigerator! Excellent! \$499 or \$20/Month

Whirlpool Air Conditioners Starting at \$199

Friedrich Air Conditioners Starting at \$145

Whirlpool NO FROST Refrigerator! Excellent! \$599 or \$28/Month

Freezers! Roper \$299

10A. HOMES FOR SALE

3 Br. 2 1/2 Bath House For Sale By Owner! CHA, New mild blinds, new paint inside, quiet neighborhood on dead end street, fenced back yard, \$55,000, 283-2500, or after 6 p.m. 283-2440.

For Sale - Right across from the park, excellent neighborhood, 901 Acre. Newly renovated. Features: Hardwood floors, granite, dual ovens, large corner lot, privacy fence and deck. Many extras included. \$58,500. 283-2620.

For Sale: 4-2 Victorian Home, CHA, being updated, owner finance! \$149,000, 283-2500, or after 6 p.m. 283-2440.

For Sale: Right outside city limits at Woodville, 3 bedroom, 2 bath House. Five acres, barn, large 3 car garage building, all fenced. Call 283-2697 after 6 p.m. 26-2b

10B. MEDICAL JOBS AVAILABLE

WANTED: LVN's and CMA's PRN Apply in person, Dogwood Trails Manor 76 Highway 190 West, Woodville. 17-4b

WIRELESS CABLE

NOW AVAILABLE ANYWHERE

If you are on Regular Cable or Satellite, you are paying too much. OVER 200 CHANNELS FREE - Including all networks and Fox. For FREE installation and Free gift call today!

Charles Lanier (409)969-2507 or 1-800-652-2552

Your Nearest TEXAS STATE OPTICAL...
Dr. Eric Penney Optometrist/Director

"Prices you can afford, quality you can see."

On the Courthouse Square 128 N. Austin, Jasper 384-4841

T.S.O.
TEXAS STATE OPTICAL
OF JASPER

64 \$2.95

FOR ONLY

PORTRAITS



1-5x10, 2-5x7 1/2, 10 Wallets, 24-Billfolds, & 27 Mini-Portraits

Bring in any lower priced advertised offer and we'll flat price it!

1121 SOUTH MAGNOLIA, WOODVILLE, TX.
WAL-MART PORTRAIT STUDIO
Bring in any lower priced advertised offer and we'll flat price it!

Call Diane 1-800-967-6271 10B. MOBILE HOMES FOR SALE

CALL FOR AN APPOINTMENT TODAY Office 283-3110 Home 283-8110 Andrea Ayers 7 Miles South of Woodville on Hwy 69

BOOSTER CLASSIFIEDS Get Results

PROFESSIONAL REALTY "25 YEARS In The Business" Billy Frank & Charlotte Eaves 283-7889 (Office) 283-2747 (Home)

1. 3 1/2 Frame, CHA, on 4.7 acres, fenced, all conveniences, water, sewer, pool, etc. \$27,000

Jackie Brown Real Estate 409-837-2973 US 69, Colmesneil James and Jackie Brown

Frog Pond Lake, 1.65 acres, wood, com. water. Terms \$3,500. Lake Amanda, Mobile Home, Waterfront lot. \$12,000

TRI-COUNTY Thelma Cain Broker/Owner

ELEGANT ESTATE HOME - Just walk into this graceful formal 3 Br. 2 Ba. building. \$70,000

409-283-3216 283-3216

East Texas Land Co. SALES - MANAGEMENT - TIMBER SAME LOCATION 23 YEARS

325 ACRES pasture, some woods along creek. Lake and campsite, four ponds, cross fenced. Very Nice Property. Call for details.

12B. APPLIANCES 129. WANTED TO BUY

12H. FURNITURE 14. EQUIPMENT

12I. HOUSEHOLD ITEMS 16A. AUTOMOBILES

129. WANTED TO BUY 19. LEGAL NOTICES

10C. ACREAGE 10C. ACREAGE

Delinquent TAX SALE LAKE LIVINGSTON - LAKEFRONT COMMUNITY 42 LARGE WOODED PROPERTIES

NOTICE OF APPLICATION TO RECONCILE FUEL COSTS Under the terms of the Commission's Final Order in Docket No. 11292, Application of Gulf States Utilities Company for Sale, Transfer or Merger...

16A. AUTOMOBILES

16B. TRUCKS

16A. AUTOMOBILES

19. LEGAL NOTICES

10C. ACREAGE

Delinquent TAX SALE LAKE LIVINGSTON - LAKEFRONT COMMUNITY 42 LARGE WOODED PROPERTIES

NOTICE OF APPLICATION TO RECONCILE FUEL COSTS Under the terms of the Commission's Final Order in Docket No. 11292, Application of Gulf States Utilities Company for Sale, Transfer or Merger...

H.E. 'Bud' Jones Real Estate 106 E. Bluff 283-5000 Woodville

CHARMING 90 year old home - 3 Br. 3 Ba, 3400 sq. BRICK HOME. \$160,000

10B. MOBILE HOMES FOR SALE

10C. ACREAGE

11A. HOMES FOR RENT

11B. MOBILE HOMES FOR RENT

11C. APARTMENTS

11D. COMMERCIAL

Use your old mobile home as a down payment on your new DREAM HOME.

10B. MOBILE HOMES FOR SALE

10C. ACREAGE

11A. HOMES FOR RENT

11B. MOBILE HOMES FOR RENT

11C. APARTMENTS

11D. COMMERCIAL

Use your old mobile home as a down payment on your new DREAM HOME.

10B. MOBILE HOMES FOR SALE

10C. ACREAGE

11A. HOMES FOR RENT

11B. MOBILE HOMES FOR RENT

11C. APARTMENTS

11D. COMMERCIAL

Use your old mobile home as a down payment on your new DREAM HOME.

10B. MOBILE HOMES FOR SALE

10C. ACREAGE

11A. HOMES FOR RENT

11B. MOBILE HOMES FOR RENT

11C. APARTMENTS

11D. COMMERCIAL

Use your old mobile home as a down payment on your new DREAM HOME.

10B. MOBILE HOMES FOR SALE

10C. ACREAGE

11A. HOMES FOR RENT

11B. MOBILE HOMES FOR RENT

11C. APARTMENTS

11D. COMMERCIAL

Read the Classifieds for great bargains!

SUMMER SALE

BASSETT Slide-By-Side \$688

CHEST 4 Drawers \$38

Sylvania 20" Color TV \$288

CORSICANA CRAZY QUILT Mattress Sale... YOUR CHOICE

Day Beds \$199

Piney Woods Warehouse Furniture & Appliances

Business Bulletin Board

Ramsey's Mini Warehouse Self Storage-NOW LEASING

Britt Construction "You Name It... We Do It"

DISCOUNT PEST CONTROL Ken DeRouen

CHAT AND CHEW WAGON Specializing In Hot Tamales

Sanderson Home Improvements

CC's DEFENSIVE DRIVING SCHOOL/U.S.A.

Anna's Tire & Lube Shop

Greg Kirkpatrick Dirt Work • Dozer Work

WOODY'S SIDING MOBILE HOME ROOF-OVERS

Increase your profits. Hang your business card on Tyler County's most visible Bulletin Board. Call 283-2516 today!

Tyler County Church Listings

Adventist
Seventh Day Adventist Church
 1 miles south of Warren, Highway 69
 Rocky Guerrero, Pastor

Agape
Agape Church
 FM 1745 837-4434
 Kenn and Gina Harrison, Pastors

Apostolic
Lakeside Apostolic Church
 429-5481, Bro. Hershel Lott, Pastor

Assembly of God
Abundant Life Fellowship
 Hwy. 190 at 92, Dam B. Tx. 283-3324
 Rev. J.D. Hughes
First Assembly of God
 R.C. Tillery, Pastor
Chester Assembly of God
 Hwy. 287, Chester, 283-7862
 Don Hensarling, Pastor
Colmesneil Assembly of God
 Colmesneil, Texas 837-4424
 J.C. Carter, Pastor
Hillster Assembly of God
 Hillster, Texas 283-2725
 Melvin D. McCallion, Pastor
Oak Grove Assembly of God
 Hwy. 92 between Fred & Spurger
 429-5050
 Rev. Wayne Watts, Pastor
Shady Grove Assembly of God
 West of Woodville
Trinity Christian Center
 Hwy. 190 West, Woodville
 283-5754
 The Rev. William Stockstill, Pastor

Baptist
Aline Independent Baptist
 1/8 miles N. of Doucette on FM3065
 Buddy McDaniel, Pastor
Beech Creek Baptist Church
 FM 1013, 3 miles west of Spurger,
 Robert McCallion, Pastor
Bethany Baptist Church
 Colmesneil, Texas
 Rev. Jack Butler, Pastor
Bethel Baptist Church
 Warren, Hwy. 1943 W. of 69
 Dr. Don Richey Sr., Interim Pastor
Calvary Baptist Church
 Hwy. 69 North, Woodville, Texas
 Rev. Bill Gardner, Pastor
Camp Zion Baptist Church
 Doucette, Texas
 Rev. I.S. Hunt, Pastor
Cane Creek Baptist Church
 Chester, Texas
 G.M. Standley, Pastor

Chester Baptist Church
 Chester, Jimmy Dean, Pastor
Dogwood Hills Baptist Church
 Hwy. 190 West, Woodville
 FM 1943, 13 miles E. of Warren
 Derrell Young, Pastor
Mount Olivet Baptist Church
 Hwy. 92, Fred, Texas
 Brian Hale, Pastor

Mt. Sinai Baptist Church
 Holly Fork Community
 Bro. Charles Haynes, Interim Pastor
New Pilgrim Baptist Church
 Woodville, 283-2277
 The Rev. Leonta White, Pastor
New Shady Grove Baptist Church
 3 m. east of Woodville, Hwy 190, 283-2607
 The Rev. Leonta White, Pastor
New Shiloh Baptist Church
 West of Woodville
 Louis Tubbs, Pastor
Oak Grove Baptist Church
 Hwy. 69/256 West 837-5439
 Jimmy Graham, Pastor
Palestine Baptist Church
 3 miles N. of Chester on Hwy. 287
 Rev. N. Joseph Jr., Pastor
Pilgrim Rest Missionary Baptist
 Cobb Mill Road, Woodville
 Rev. R.L. Session, Pastor
Pleasant Hill Baptist Church
 401 M.L.K., Woodville 283-3008
 C.O. Hinton, Pastor
Rockland Baptist Church
 Bro. John Lewis, Pastor
Rocky Springs Baptist Church
 Pastor
 Tom Owen, Pastor
New Zion Baptist Church
 Spurger, Lester Mitchell, Pastor
Harmony Baptist Church
 Hwy. 256, off Highway 190 West
 Bro. Steve Ford, Pastor
Hebron Baptist Church
 5 miles south of Warren, Hwy. 69
 Hillster, Texas
 W.R. "Bill" Swearingen, Pastor
Hilltop Baptist Church
 Hwy. 190, west of Dam B
 Kenm Freeland, Pastor
Katy Baptist Church
 Colmesneil, Texas - 837-2022
 Duri Patrick, Pastor
Little Baptist Missionary Church
 1 mile east on FM 1013
 Rev. Bobby Cruse, Pastor
Little Flock Missionary Baptist Church
 Hillster, Texas 547-3336
 Rev. J. Greene, Pastor
Midway Missionary Baptist
 FM 1943, 10 miles E. of Warren
 Rev. C. Collins, Pastor
Mt. Carmel Baptist Church
 Colmesneil, Texas
 Jack Lowellen, Pastor

Christian
First Christian Church
 109 Charlton, Woodville
 283-2449
 John Bohneke, Minister

Church of Christ
Dan B Church of Christ
 15 miles E. of Woodville on Hwy. 190
 283-7746, Alvin Ickles, Minister
Pine Street Church of Christ
 604 Pine (Hwy. 287 & Nellus St.)
 283-8328, Don L. Byler, Evangelist
Warren Church of Christ
 Warren, Texas 547-2785
 Jeff Little, Minister
Woodville Church of Christ
 Hwy. 190 West 283-5977
 Eugene Greer, Minister

Church of God
White's Chapel Church of God in Christ
 302 Black Gum, Woodville, 283-7095
 The Rev. Lenon White, Pastor

Episcopal
St. Pauls Episcopal Church
 1 mile W. of Woodville on Hwy. 190
 283-3710
 Rev. Nick Novak, Vicar

Inter-Denominational
His Place Family Outreach
 305 W. Bluff St., Woodville 283-5888
 Ron Davis, Pastor
Woodville Christian Center
 203 E. Bluff, Woodville, 837-2559
 Russ Warner, Pastor

Latter Day Saints
Church of Jesus Christ L.D. Saints
 Hwy. 92, Fred, Texas
 James Odum, Branch President
Church of Jesus Christ L.D. Saints
 Pine St. Chapel, Woodville
 Tim Durr, Branch President

Lutheran
Faith Lutheran Church
 704 W. Holly, Woodville 283-7171
 Walter P. Snyder, Minister

Methodist
Cade Memorial United Methodist
 Chester, Texas
 The Rev. Frank C. Cady, Pastor
Hopewell First Congregational
 7 miles E. of Woodville, Hwy. 190
 283-5070, Jesse R. McKee, Pastor

Midway United Methodist
 563-2695
 Bob Fosburgh, Pastor
Spurger United Methodist
 Spurger, Texas
 Rev. John F. Allen, Pastor
Warren United Methodist
 Warren, Texas 547-2669
 Rev. Bob Fosburgh, Pastor
Woodville United Methodist
 Woodville, Texas
 Bobbie Weber, Pastor

Non-Denominational
Christ Holy Temple
 Clear Springs Community, 283-5668
 D.R. Mitchell, Pastor
Christian Life Center
 335 White Tail Ridge, Woodville
 283-5331
 Bro. Leonard Witt, Pastor
Community Church
 73 FM 1746, Woodville
 R.L. Sanders, Pastor 429-3646
Hampton Full Gospel Church
 2 miles W. of Chester on Hwy. 287
 Rev. James T. Loving, Pastor
New Creation
 Hwy. 190, Timberland W. &
 Old Livingston Hwy.
 Arthur McMinis, Pastor
River Acres Full Gospel Church
 Sheffield Ferry, Spurger
 Rev. Clovis Ford, Pastor
Sandy Creek Community Church
 Sandy Creek Rd., Fred, Texas
 William Smith Sr. & Yonita Smith, Pastors
The Tabernacle
 White Tail Ridge west of Woodville (four
 miles off Highway 190)
 Lonnie and Debbie Ashton, Pastors
Woodville Gospel Tabernacle
 2 1/2 miles N. of Woodville on Hwy. 69
 283-2156, David Emmons, Pastor



PHOTOS BY BOB BOYKIN

1994 Tyler County Senior League & Girls Softball League Ball Park Review

TYLER COUNTY SENIOR LEAGUE STANDINGS



Twins

Kevin Mitchell, Brett Hanks, Matt Satterwhite, Lane Weaver, Jeremiah Greenwood, Jerry Nugent, Randy Fuller, Jerry Gray, Lloyd Evans, J. R. Tillerson and Lonnie Broom. Coach: Mark Hanks.



Yankees

Weston Bryant, Jeremy Haynes, Dale Jones, Jeremy Grimes, Charles Haffa III, Charles Montgomery, Nathan Pilgrim, Henry L. Shano, Shelton Thomas, Isaac Unsworth, Joel Waldrep, D. J. Williams and Andrew Reid. Coaches: Russ Pilgrim, Bill Bryant and Hubert Unsworth.

No Photo Available
Rangers
 Luce Johnson, Chess Adams, Chad Whitworth, J. R. Davis, Robert Berry, Jonathan Mahan, Mark Guerrero, Carlos Miller, J. C. Reagan, Brandon Harris and Michael Butler. Coach: Jerry Mahan.

Want a piece of the action? ...support all Tyler County Baseball & Softball Teams!
 The future is in our kids!

TYLER COUNTY SENIOR LEAGUE STANDINGS



Indians

Clay Brown, Eugene Chessier, Burt McKinley, Chris Jones, Jason Moore, Jonathan Flocke, Brandon Monk, Charlie Carter, Thomas Riley, Dewey Cole, Jeremy Simon, David Johnson, John Leblanc and Daniel Johnson. Coaches: Linda Moore and Jeremy Moore.

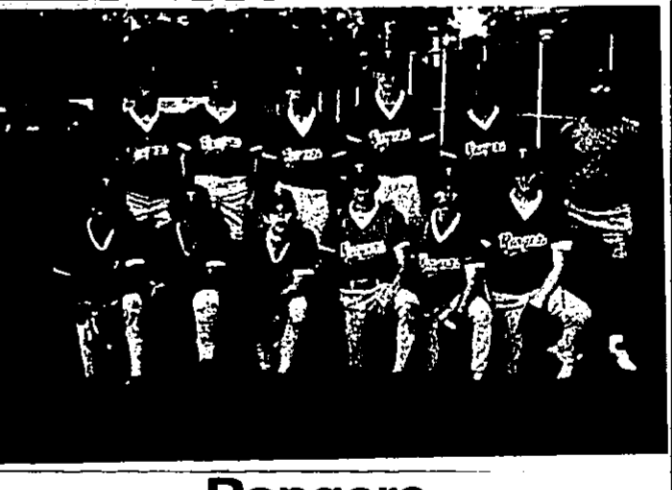

Rangers

Jake Ard, Zeb Barnes, Brent Parks, Billy Jack Sturrock, Casey Whitworth, Jason Bendy, Jake David, Trey Barnes, Paul Johnson, Toby Tolar and Steven Jewell. Coach: Chmi Sturrock.

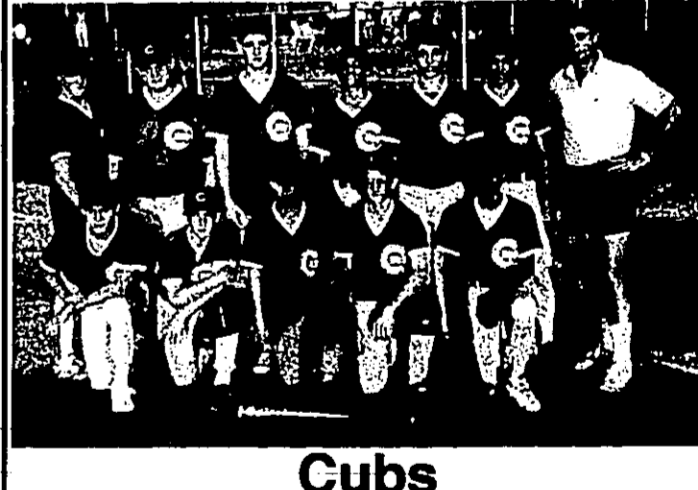

Cubs

Wade Baulwen, Lucas Bahin, Shane Moses, Ryan Weaver, Jathan Borel, Nathan Maddox, Will Shaw, Jimmy Solomon, Isaac Lockhart, Josh Perltz, Brandon Robinson and Justin Strickland. Coaches: Tommy Weaver and Bob Borel.



Cardinals

Clay Bendy, Greg Cheney, Raymond Desadler, Ray Dobbins, Daryl Douglas, Jared Leebetter, Justin Mitcham, Allen Moffett, Clinton Nelson, J. R. Pisman, Lance Seaman, Josh Shults, B. J. Stewart, Brandon Ward and Luke Wilkinson. Coaches: Diz Desadler and Alex Davis.



Twins

Timothy Dennis, Mitch Satterwhite, Chris Gill, Chris Avery, Rety Buttsie, Charlie McCallough, Marcus Blackmon, John Mark Lane, James Buford, Bryon Phillips and Patrick Dean. Coaches: Patrick Cherry and Luke Satterwhite.



White Sox

Marcus McCabe, Justin McCabe, Rick Fortenberry, Jason Kimball, Curtis Judlet, Brandon Lewis, Jason Winkle, Addison Scott, Ed Sullivan, Steven Hanley, Ron Davis, Zach Davis and Adam Greenwood. Coaches: Gordon McCabe and Rick Fortenberry.

Church News

Hilltop Baptist plans Bible school
 DAM B — Hilltop Baptist Church of Dam B will host a Vacation Bible School July 11-15 from 9 a.m. to noon daily. Classes will be open to those from ages four through nine who have completed the sixth grade.
 Teenagers will have a separate evening session during August. Teens will be involved in the July school, however, as teacher's aids.
 Friday, July 15, will be sack lunch day. All students will be asked to bring a lunch and stay for a safety program following the meal.
 The theme of this year's Bible school will be "All of Treasures." Children will be given "treasures" during the week for perfect attendance and other projects. Games, music, activities and fun will be experienced by each student daily.
 Refreshments will be served daily and transportation will be available if the student or parents contacts the Rev. Kenm Freeland, pastor, at 429-3729.

Gospel singing program resumes
 COLMESNEIL — The Oak Grove Baptist Church will resume its monthly gospel singing programs beginning at 7 p.m. Saturday, July 9, at the church located off RR 255 near Colmesneil.
 Lloyd Dunham, Sherry Walker and the Mt. Hope Baptist Church choir from Colmesneil will bring special music.
 Pastor Jimmy Graham has invited the public to join in the music and fellowship. Refreshments will be served following the singing.

Emmanuel marks 9th anniversary
 DOUCETTE — The ninth anniversary of the Emmanuel Baptist Church will be observed starting with the 9-45 a.m. Sunday school programs on Sunday, July 10.
 The observance will continue during the morning worship service, during a special dinner and with gospel singing during the afternoon.
 Past ministers and former members are invited along with the public.

Spurger students, leaders attend Acteens convention

BIRMINGHAM, Ala. — Six girls and two leaders from the First Baptist Church in Spurger attended the four-day National Acteens Convention which ended June 24 at the Birmingham-Jefferson Civic Center.
 Leaders from the church included Eva Jones and Vickie Nugent while the girls attending included Christina Blount, Erin Drennon, Emily Loving, Amber Walker, Jessica Sheffield and Holly Nugent.
 Sponsored by the Southern Baptist Women's Missionary Union, the convention is held every five years for girls in grades seven through 12.
 The primary, missionary testimonies and commissioning service, a birth-day celebration, conferences on such topics as gangs, race relations, homosexuality and sexual abstinence, and an array of missions ministry opportunities competed for the attention of 13,500 Southern Baptist teen girls and their leaders during the event.
 The teenagers opened the convention in downtown Birmingham by learning a new song, "Heart of the Younger," sung by Michele Wagner of Cleveland, Ohio, a contemporary Christian singer. The song served as the theme of the convention.
 A procession of flags of 126 countries where Southern Baptist missionaries have worked led to a challenge for the girls to commit themselves to take the Christian message to others.
 Testimonies of missionaries ranged from the difficulties of sharing the Christian faith with Navajo Indians in New Mexico to reaching out to apartment complexes and mobile home parks in Jackson, Miss., through Vacation Bible Schools, tutoring and cooking classes.
 In a series of specialized conferences the teenagers were introduced to a new Southern Baptist program called "True Love Waits" which encourages persons to commit to sexual abstinence until marriage.
 Specialists in race relations cautioned the teenagers about using slang terms in referring to people of other races "because it really hurts."
 At a conference on homosexuality, Lane Powell, professor of human relations at Samford University, Birmingham, reminded the girls that while homosexuality is a sin in the Bible that Christians should show compassion just as Jesus did in dealing with outcasts.
 To show their concern for others, the girls brought 5,000 teddy bears and 7,000 pairs of canvas shoes for their missionaries to distribute to the needy where they work.
 Between specialized conferences and general sessions, the teenagers flocked to a large exhibit hall designed as a city where they personally interviewed missionaries while making video tapes and audio cassettes for use later in their churches.

Sunny Dell homecoming slated
 COLMESNEIL — The Sunny Dell Church will observe its 112th anniversary during the annual homecoming event to be held Sunday, July 24, at the church, located five miles west of Colmesneil.
 The organization known as Homecoming Event also will celebrate its 40th anniversary at the session. Officers for 1993-94 are President Ann Crews Laird, Vice President Dr. Sam Mann and Secretary-Treasurer Bobbie Sturrock-Hopson. Trustees include Dr. John M. "G.W." Sturrock, Tommy Swiatek, Craig Sturrock, Frances Pittman Lilly and Maxie Sturrock Swiatek.
 The song service will begin at 10:30 a.m., followed by a business meeting. Kendall Barnes of Nacogdoches will bring the message for the day.
 A special invitation is extended to daughters, granddaughters and great-granddaughters of former pastors.

Revival slated at Beech Creek
 SPURGER — Evangelist Sonny Holland will lead revival services planned Sunday, July 31, through Wednesday, Aug. 3, at the Beech Creek Baptist Church located near Spurger.
 The services will begin at 6 p.m. on Sunday and at 7 p.m. Monday through Wednesday.

Gospel meeting set in Dam B
 DAM B — The Church of Christ at Dam B will host a gospel meeting July 10-15, 7-9:30 a.m. nightly.
 Gene Sanford of Rosenberg will be the preacher.

Nita's Fashion Located at The Woodville Inn Saturdays only 283-3741 or 969-2677	E & L Lumber Co. 1201 N. CHESTNUT, TEXAS 283-2622	FEW READY MIX Woodville, Tx	Woodville Convalescent Center Living with dignity. Aging with understanding. Caring with pride. 102 N. Beech 283-2554 Woodville
KNAPP FORD Corner of HWY. 190 & 287 283-2526	CITIZEN Member FDIC P.O. Box 109 Woodville, Texas Since 1920	A & M MOTOR CO. INC. Pontiac • Buick • Oldsmobile • GMC Trucks 283-2534	Jarrott's Pharmacy "Serving Tyler County Since 1952" 205 S. Magnolia 283-2550 Woodville
Davis Food Market WATER, TX. 547-3399	WOULD YOU LIKE TO ADVERTISE HERE? CALL 283-2516	Bookshire Bros. "The Best For Less" 283-3333 Woodville, Texas	WOULD YOU LIKE TO ADVERTISE HERE? CALL 283-2516
DOGWOOD TRAILS MANOR 78 Hwy. 190 West 283-5147 Woodville	Allison Chevrolet Hwy. 48 E. Colmesneil 283-7493	Bestway Foods	FIRST National Bank WOODVILLE BRANCH Your Full Service - Full Time Bank 283-6231 Hwy. 190 E. Woodville
WALMART 1775 Hwy. 190 West 283-5148	McDonald's of Woodville "We have Pizza & Pasta" 283-5855	THE TYLER COUNTY BOOSTER Serving the people of Tyler County Since 1930	TEMPLE-INLAND FIRST FRUIT INSURANCE CORPORATION



T-Ball National All-Stars
Cody Cox, Jared Wallace, Zack Lundy, Jay Reese, Blake Buckner, Craig Thompson, Drew Brown, Philip Brown, Coney Beck, Michael Toucha, Courtney Williams, Shawn L. Johnson, Justin Benton, Alex Rigby, Steven Dodd, and Joshua Cruise



T-Ball Sweethearts
Doris McCarrich, Kelli McKee, Corby Weyler, Heather Handy, Mengian Tillery, Jania Thompson, Carrie Spivey and Hillary Wade

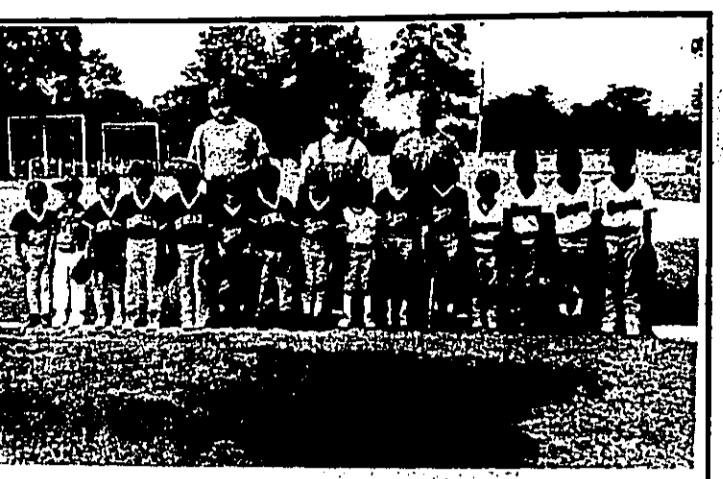

T-Ball American All-Stars
Justin Cherry, Shawn McQueen, Wesley Walker, Dewey Rivers, Cullen Williams, Jake Hickman, Jordan O'Neal, Trevor Rainey, Jarrod Johnson, Chad Williamson, Gary Bullock, Logan Alec, Micha Robinson, Manning Robinson and Brandon Ellis

TYLER COUNTY T-BALL LITTLE LEAGUE



Astros
Casey Beck, Steven Dodd, Nicholas Fullingim, Rafe Fullingim, William Hardy Jr., Brady Kirkland, Adrian Mack, Cory Maxwell, Cody Pace, Alex Bigsby, Cody Toucha and Michael Toucha. Manager: Dennis Atwell; Team Mom: Tammy Maxwell and Mary Maxwell

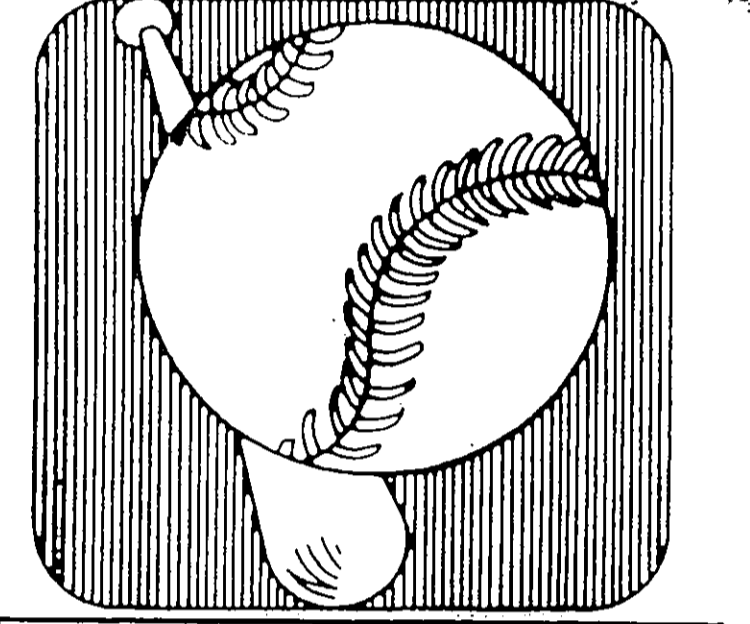

Blue Jays
Justin Kirkpatrick, Bryan Barlow, Bryan Hughes, Jesse James, Chad Willman, Dusty Procter, Daryl Parish, Aaron Hicks, Joshua Mitchell, Jonathan Beauchamp, Marshal Valley, Robert Zanotti, Donnie Releford, Cody Baschlagie and Aaron Sanford. Manager: John M. Killam; Coaches: Jimmy Willman and Steven Parker.



Indians
Micah Robinson, Manning Robinson, Courtney Battise, J.R. Bullock, Cassie Battise, Jason Williams, Mitchell Alec, Kirk Sylestine, Janai Thompson, Kerrie Sylestine, Stacey Langley, Gregory Battise, Ross Abbey, III and Logan Alec. Manager: William Sylestine; Coach: Floyd Poocho.



Marlins
Kael Little, Krystalle Mayer, Justin Jeffcoat, Justin Brown, Clint Gage, Cliff Renick, Levi Foxworth, Brandon Ellis, Travis Hutton, Marcus Wallace, Derek Wise, Brandon Sims, Ricky Joe Wood, Matt Sweeney and Joseph McCullum. Sponsor: Warren Baseball. Manager: Susan Wise; Coach: Linda McCullum; Sweetheart: Kellie McKee; Team Mom: Darlene Sims.



Mets
Chase Nalley, Corday Williams, Matthew Williford, Matthew Dahill, Ely Broom, David McCullister, Christopher Haven, Broderick Marchison, Shane Todd, James Fonder, David Ponder, Robert Gilder, David Summers and Drew Broom. Manager: Russ Nalley.



Phillies
Brad Belschner, Joshua Cruise, Jake Lutz, Tyler Lutz, Brodrick Mitchell, Christopher Poindexter, Samantha Poindexter, Cody Powers, Cody Powers, Zack Rigby, Christopher Smith, Daniel Spivey, Kelli Stephens and Troy Turner. Manager: Brent Belschner; Coach: Stuart Lutz.

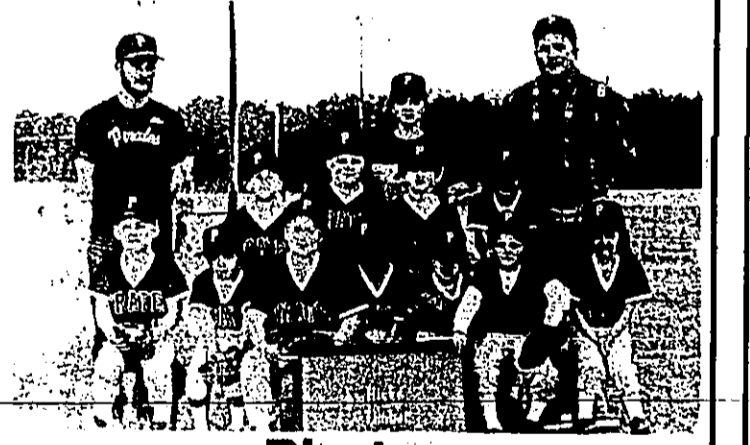

Pirates
Sam Carson, Rusty Mott, Shawn Jordan, Rachel Hutto, Ben Mott, Jason Griffith, Heather Golden, Johnny Whitaker, Bill Osborn, Justin Benton, Charles Jordan and Philip Whitaker. Manager: Allen Benton; Coach: Billie Jordan



Rangers
Jason McKnight, Dewey Rivers, Sean McQueen, Joshua James Marceaux, Justin Cherry, Dustin Woodrums, Clint Tolar, Zachary Pounds, Wesley Walker, Cody Welch, Kayla Cook, Sunni Hubert, Amber Walker, Kandi Hooks and Megan Standley. Manager: Ray McKnight.



Reds
Micah Crews, Tanner Sigard, Steve Brown, Dallas Gullitory, Sean Lantzer, Dallas Patrick, Brandon Rainer, Hillary Ward, Katharine Gallagher, Jennifer Russell, Chip Thompson, Aaron Bryant, Joshua Godfrey, John Belschner and Daniel Ellis. Sponsor: East Texas Insurance; Manager: Lonnie Flowers; Coach: Kenneth Adaway

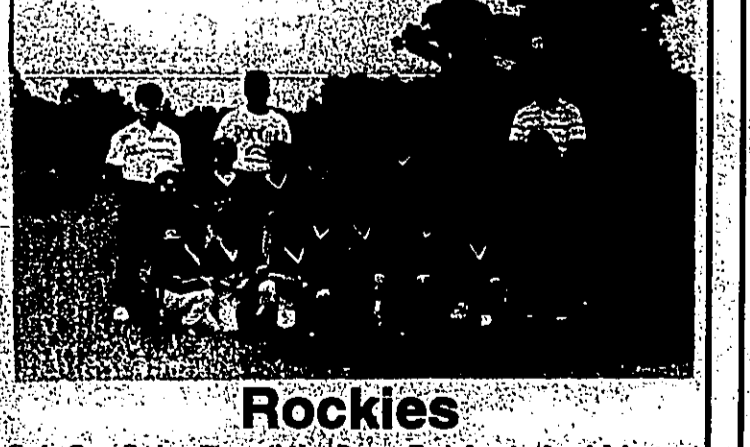

Rockies
Cody Cox, Corban Thornell, Jay Reese, Zach Lundy, Jarrod Johnson, Jared Tipton, Richard Sumrall, Todd Earl, Jerred Wallace, Blake Buckner, Cates Keith, Durrell Johnson and Clinton Ard. Sponsor: Spindletop Street Rods; Manager: Charlie Cox; Coaches: Clint Hutton, Drew Thornell, Ronnie Reese and Paul Lundy; Sweetheart: Corby Weyler; Team Mom: Karol Cox.

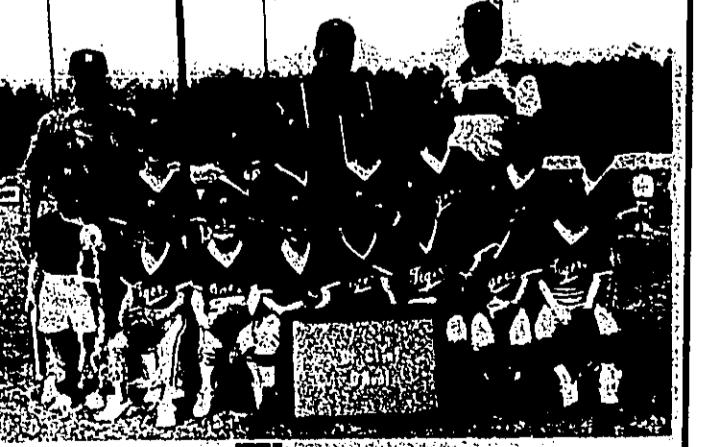

Tigers
Latarron Pickett, Cullen Williams, Matthew Cruise, Baylor Butler, Zack Loving, Jake Hickman, Justin Smith, Trevor Rainey, Brent Blanchette, Malcom Lewis, Jordan O'Neal, Brent Elrod, Jarrod Johnson and Jarrod Lemie. Manager: Clint O'Neal; Coach: C. S. O'Neal.

SINCLAIR CHILDREN'S CENTER

E&L LUMBER COMPANY

E&L LUMBER COMPANY

TYLER COUNTY PITCHBALL LITTLE LEAGUE



Pitchball American Allstars
Dallas Hutton, Levi Townsend, Jake Colton, Garrett Rish, Travis Copeland, Josh Rogers, Caleb Phipps, Robin Morris, Brandon Pate, Brock Hanks, Casey Housh, Martin Spurlock, Brad Stephens, Chris Tribble, Corey Haven.



Pitchball Sweethearts
Christy Ogden, Melissa Chaney, Nikki Ray, Rachel Beauchamp and Janay Taylor



Pitchball National All-Stars
Jim Bass, Ryan O'Neal, Bryan Carruthers, Elish Gray, Jacob Williford, Brandon Temple, Blake Brown, Jared Carter, Joey Cady, Jake Rutherford, Michael Hart, Jason Allen, Michael Hadnot.



Astros
Ryan O'Neal, Bryan Carethers, Jacob Williford, Brandon Temple, Jared Carter, Jake Rutherford, Michael Hart, Bennett Champagne, Micah Hadnot, Brad Elrod, Jonathan Martin and Mathew Birdwell. Manager: Greg Temple; Coach: Randy Carter.



Cardinals
Kyle Harrison, Jon Rose, Blake Brown, Cody Hanks, Chad Hanks, William Shutter, Elijah Gray, Jon Patrick, Michael Gryder, Joey Cady, Jim Bass and Jason Allen. Sponsor: Gardner Oil Co.; Manager: Robert Gray; Coaches: Villa Spurlock and Kirk Brown.

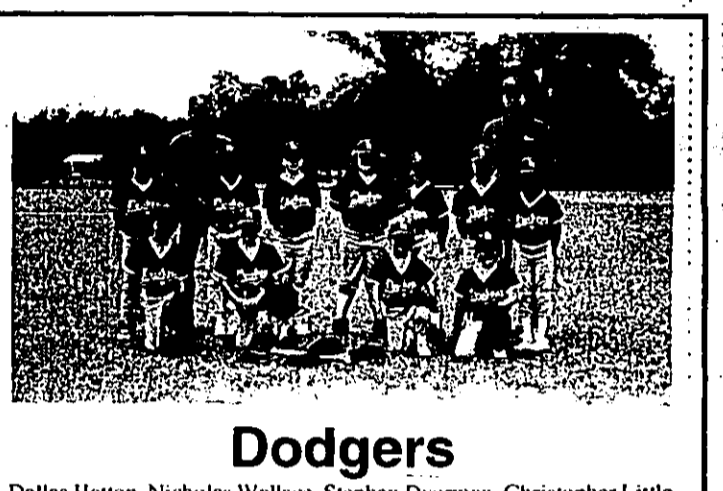

Dodgers
Dallas Hutton, Nicholas Wallace, Stephen Dvorman, Christopher Little, Chris Hooper, John Michael Lee, Robie Morris, Aaron Dickey, Rachel Beauchamp, Jarrett Mowzinga, Joey Brown and Danny Rose. Sponsor: B & J Amusements; Manager: Jack Morris; Coaches: Kevin Dickey, Bobby Risch and Keith Hutton; Sweetheart: Rachel Beauchamp; Team Mom: Melanie Hadnot.

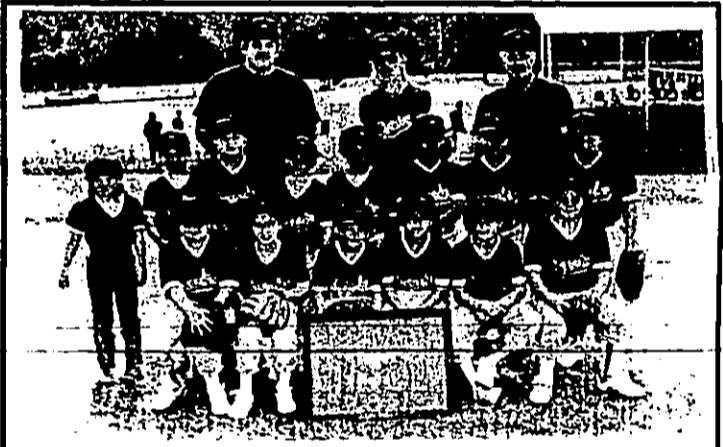

Orioles
Devan Blaylock, Brandon Pate, Tommy Richardson, Casey Hough, Corey Havens, Chris Gonzales, William Dabill, Christopher Tribble, James Morgan, Danny Meshel, Jared Taylor, Cliff Russell, Joshua Rogers and Aaron Dickey.

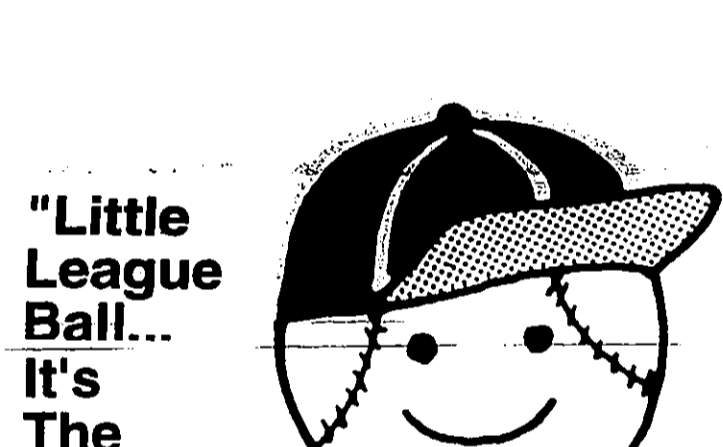

K.C. Royals
Jake Cotton, Levi Townson, Brad Stevens, Brock Hanks, Calih Phipps, Martin Spurlock, Travis Coplen, Michael Adams, Jimmy Wilman, Michael Lane, Brad Evans and Reggie Wise. Manager: Larry Coplen; Coaches: Brian Bell and Charles Spurlock.

"Little League Ball... It's The Best!"



JARROTT'S PHARMACY

The Tyler County
Booster
Where You'll
find all your
Tyler County
sports news!

Jacques Blanchette: 'The Voice of Tyler County Baseball'

On almost any baseball night at Hennigan Baseball Park in Tyler County, the fans are continually amused by the spontaneous chatter of official Baseball Park announcer Jacques Blanchette.

Not only does he sound like a real pro, but officials from other baseball leagues have tried to take him home with them to help put on their own baseball tournaments.

"Win or lose, said one fan, you feel like you've been given something when you leave the game. Baseball's fun anyway, but Jacques makes it special!"

Before he goes anywhere to any other town, said County Sheriff Gary Hennigan, who is also the League President, "They'll have to get me to say OK...and," he added, "don't hold your breath."

Jacques Blanchette

TYLER COUNTY MINOR LITTLE LEAGUE

TYLER COUNTY MAJOR LITTLE LEAGUE



Braves

Ryan Foxworth, Kerry Harrison, Philip Graham, Jim Ed Mann, Chris Douglas, Mathew Bristow, Daniel Cady, Jake Snider, Brandon Snider, Nathan Bryant and Hunter Mann. Sponsor: Davis Grocery; Manager: Jeff Mann; Coach: Charles Ross.

DAVIS GROCERY-WARREN



Minor: 9-Year-Old Allstars

Chad Beck, Shawn Bible, Heber Odum, Jerred Buckner, Daniel Cady, Joshua Falcon, Jason Ferguson, Nicholas Foret, Clay Hensarling, Quincy Mack, Derek Marshall, Tawn Mitchell, Travis Morell, Jacob Terrell and Adam Grissom.

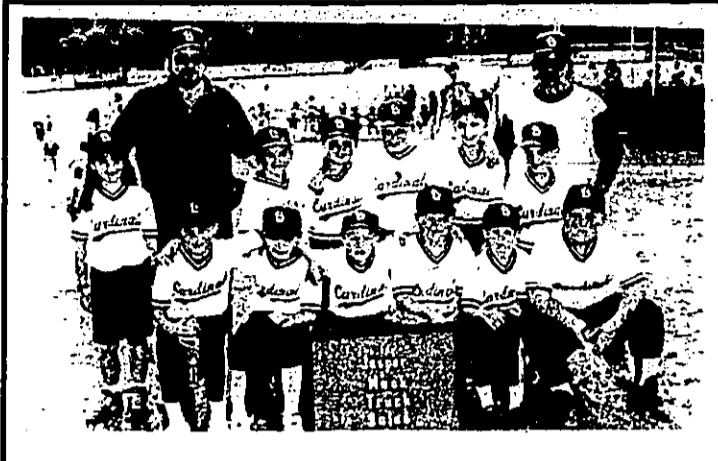

Cardinals

Josh Worby, Brandon Worby, Brandon Simmons, James Gallagher, Billy Miller, Derek Marshall, Robert Harry, Keith Hughes, Jason Ferguson, Donald Thompson and Kaleb Hughes. Sponsor: Mack Truck Sales - Jasper; Manager: Doug Harry; Coach: Chester Marshall.

TYLER COUNTY BOOSTER



Astros

Timothy Durr, Jeff Davis, Reid Parker, Bryan Gay, Jesse Gay, Jimmy Kirk, Samuel Pate, Robert Watson, Jess Payne, Damon Radcliff, Kevin Barclay, Richard Barnhart, Wesley Fowler and Brian Hough. Manager: Tim Durr; Coach: Ron Davis.

FDI COMMUNITY BANK



Major Sweethearts

Leah Bearden, Jennifer Loupe, Bridgette Snider, Mary Ann Gay, Samantha Bible, Pamela Taylor, Fawn Bullock and Jennifer Loving.

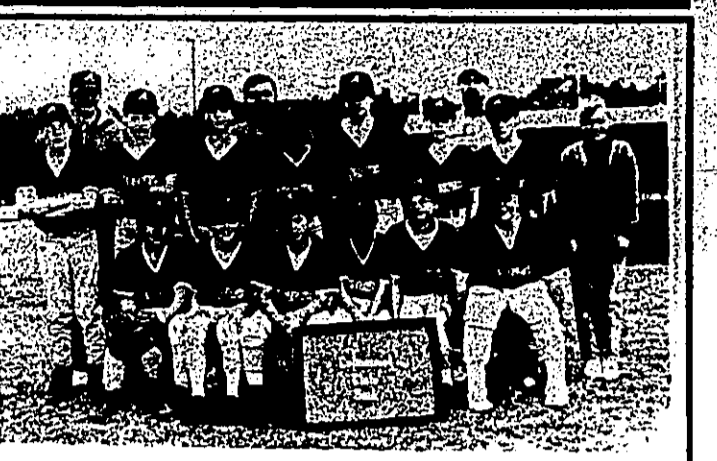

Braves

Blake Belt, Zach Ward Aron Pickens, Ryan Hightower, Jesse Mahan, Jason Gibbs, Whit Harris, Roderick Douglas, John Knox II, Ricky Martin, Kevin Pentecost, Blake Pentecost and Chad Harry. Manager: Mark Martin; Coach: Elton Hightower.

1ST STATE BANK, COLMESNEIL

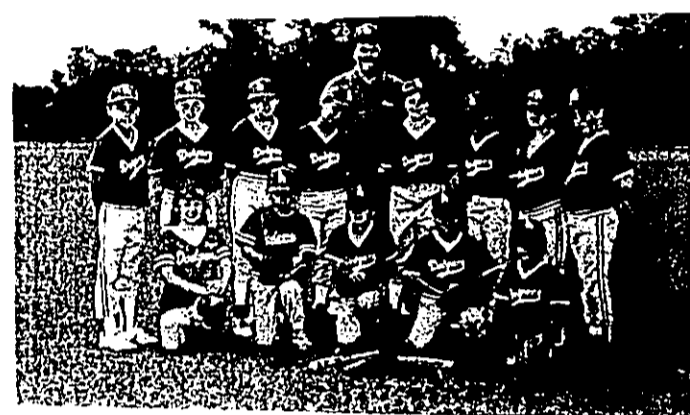

Dodgers

Joshua Keith, Danny Rose, Toby Earl, Justin Hatton, Cody Byrd, Eric Foxworth, Melissa Sumral, Joey Mayer, Cody Crawford, Matt Crawford and John Shearer. Sponsor: Wildwood Resort; Manager: Rick Earl; Sweetheart: Krystle Cox; Team Mom: Diane Rose.

WILDWOOD RESORT



Minor-10-Year-Old Allstars

Nathan Nichols, Drew Tucker, Brandon Kinard, Jed Townsend, Brian Martin, Derek Hardin, Billy Milner, Brian Chapman, Trent Obama, Caleb Black, Noel Hood, Ross Johnston, Brandon Snider and Patrick Hadnot.



Giants

Shawn Bible, Tawn Mitchell, Germany Johnson, Zachary Lyn Moyer, Casey Lynn Clow, Trent Obama, Rarick Hadnot, Tony Wooten, Ed Barlow, Mackenzie Lockhart, Cody Rutherford and Ethan Bahiss.

A-Z AUTO PARTS

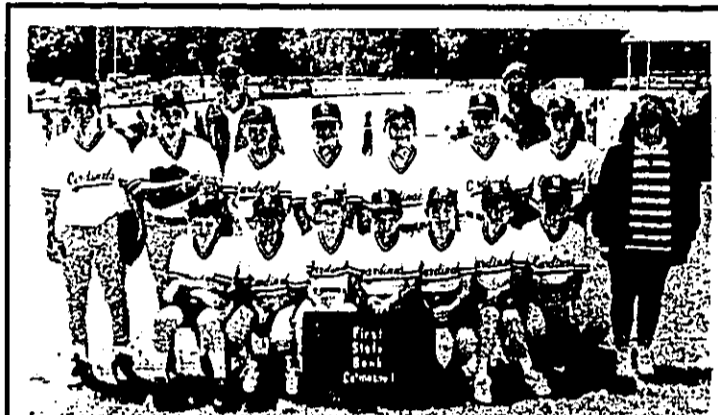

Cardinals

Jeremy Brown, Michael Patrick, Brad Carter, Matthew Wilkinson, Chad Prick, Joshua Brown, Cody Worthy, Cole Crews, Shane Daniels, Andrew Hallio, Bobby Foxworth, David Mahan, Josh Marshall and Daniel Fowler.

1ST STATE BANK, COLMESNEIL



Indians

Colin Poncho, Rodman Syssetine, Elliott Abbey, Patrick, Patrick Batusse, James Thompson, Jordan Williams, Travis Crosby, Bradley Walker and Tobine Alec. Coach: Alton Lee Syssetine.



Dodgers

Caleb Black, Scooter Ard, Christopher Grant, Jonathan Moore, Brian Yawn, Scott McAbee, Dwight Sanford, Adam Beough, Lance Squires, Timothy Hooper, J. P. Bearden and Matt Dees. Sponsor: Rice Grocery; Manager: Steve Black; Coaches: Clyde Bearden, Gary Lachance, Prentice Black and Shaun Black; Sweetheart: Leah Bearden; Team Moms: Terri Yawn and Nancy Beough.

RICE GROCERY

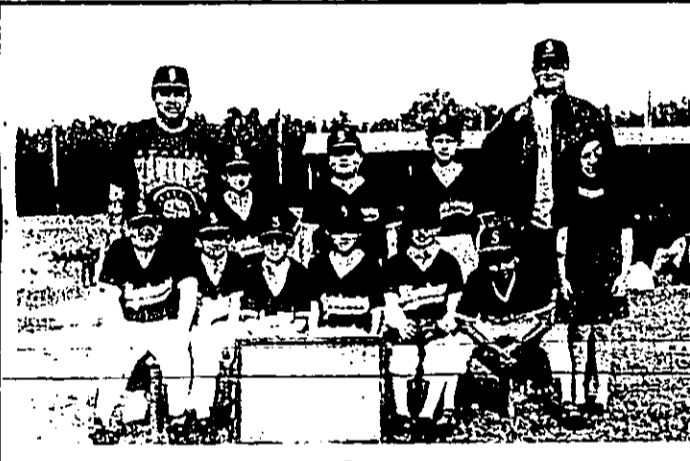

Mariners

Garett Blake, Robert Blaylock, Brian Casey Champagne, Joshua Lee Falcon, Heber Odum, Mark E. Rainwater, Brandon Thibbels, Barry Blaine Whisenant, Chris Williams, James Deway Williams and Buddy O'Hara. Manager: Lindsey Whisenant; Coach: Tony Falcon.

LINDSEY WHISENHANT



Mets

T. J. Lingle, Brandon Mitchell, Darrell Morris, Mark Philpott, Dustin Barlow, Clint Dean, Jared Dean, Michael Summers, Chad Beck, James Harvey, Will McNally and Steven Scott. Manager: Mark McColister; Coach: Kelly Beck.

CROWN CABLE

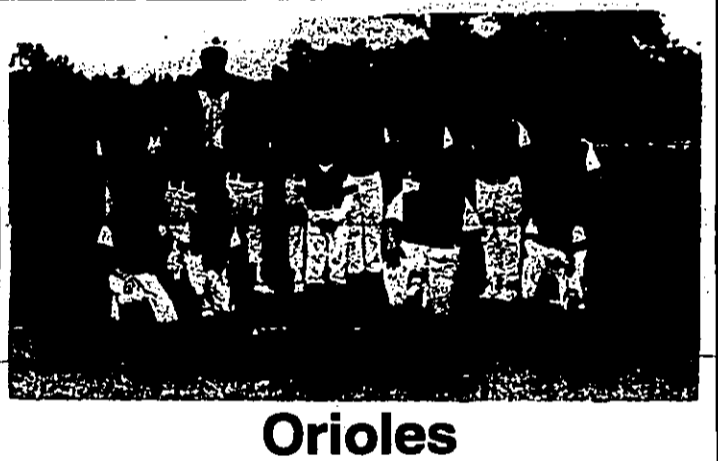

Orioles

Jacob Terrell, Travis Morris, Jarrod Buckner, Steven Riley, Toshia Jacobson, Christopher Linn, Keegan Rivers, Jeremiah Cole, Timothy Wigley, Matthew Cryer and Bryan Davis. Sponsor: Wildwood Country Store; Manager: Marlin Riley; Coaches: Keith Buckner, Danny Terrell and Randy Linn; Sweetheart: Amanda Riley; Team Mom: Theresa Morris.

WILDWOOD COUNTRY STORE



Mets

David Davis, Christopher Dotson, John Grimes, Stephen Haynes, Jason Hickman, Travis Licox, Jarrod Odum, John Sowbarby, Cody Tillerson, Cecil Wade, Tom Wood, Michael Hanna and Bobby R. Cawley. Manager: Paul Wade; Coach: Tommy Tillerson.

FEW READY MIX



Rangers

Cory Whitworth, Matt Bryan, Derrick Reggie, Brandon Reggie, Keith Jones, Johnathan Barnes, Jacob Standley, James Ray Kimball, Antwan Morris and Tim Daniels. Manager: Bob David; Coach: Chris Bodley.

WOODVILLE HARDWOOD



Rockies

Matthew Adams, Cuyler Zimmerman, Josh Coke, Paul Loupe, Josh Nichols, Kirk Foret, Frederick Dunham, J.P. Landry, Justin Ray, Joshua Muller and Duac Tipton. Sponsor: Coko Enterprises; Manager: Mitchell Zimmerman; Coaches: Bobby Nichols and Courtney Zimmerman; Sweetheart: Jennifer Loupe; Team Mom: Rene Zimmerman.

TYLER COUNTY TRACTOR



Padres

Dustin Stafford, Jed Townsend, Jonathon Gardner, Steven Reed, Trey Harvey, Jonathon Haynes, Seth Novek, Isaac Rodriguez, Quincy Mack, Frazierale Releford, Arlian Hadnot and Shaun Reed. Manager: Randy Stafford; Coaches: Jerry Townsend and John Reed.

J&S DRUGS



Pirates

Chandalyan Lilley, Josh Radcliff, Charles Lilley II, Joshua Arney, Robert Bates, Bradley Mott, Dustin Mitchell, Richard Gill, Jason Ogrodovicz, Jimmy Grissom, Brian Griffin and Brian Owens. Manager: Martin K. Mott; Coach: James Ogrodovicz.

TYLER COUNTY BOOSTER



Rangers

Joshua Toney, Jared Torrez, Brandon Johnson, Noel Hood, Ray Cook, Richard White, Justin Lira, Ross Wade Toler, Matthew Walker, Mark Torrez and Jared Davis. Manager: Bryan Davis; Coach: Gordon Toler.

CHILDRESS MONUMENT



Tigers

Michael Barlow, Paul J. Berryman, Brandon Cruise, Jeffery Wayne Cruise, Tony Foster, Roy Glenn Gay, James Haffa, Greg Harwell, Calvin Brian Hough, Evan Lane, Michael Parish, Robert Lynn Prosperite, Joshua J. Williams and Brent Allen. Manager: Alton Harwell; Coach: Matt Bochot.

E&L LUMBER COMPANY



White Sox

Bela Nagypal, Michael Evans, Chad Johnson, Clinton Greer, Josh Byron, Jason Scott, Brad Wise, Robert Hughes, Dantony Cook, Adam Brochtrup, Orrin Dean, Lucas Brown, Justin Scott and Chevis Smith. Manager: Bela Nagypal; Coach: Steve Evans.

KELLER

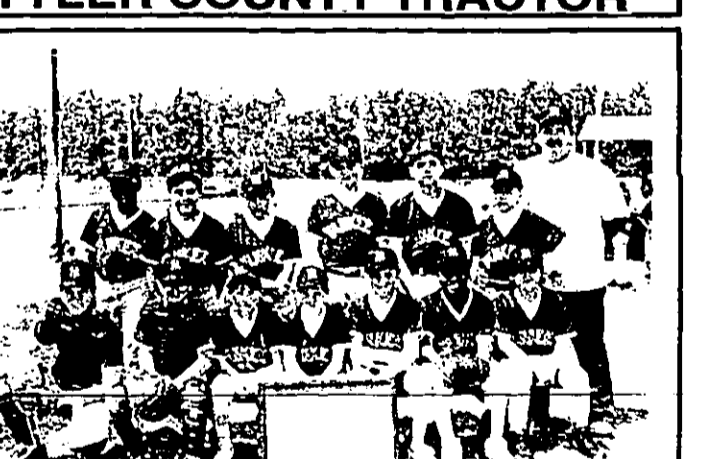

Yankees

Corey Bean, Garlon Blake, Monty Dattalo, Chase Farr, Trey Grammer, Jeremy Hall, C. D. Hicks, James Jackson, David Johnson, Jared Midkiff, Trey Scales, Brian Walker and Scott Ward. Manager: Tom Webster.

A&M MOTOR COMPANY



Red Sox

Jessica Benick, Joshua Lacy, Nathan Nichols, Blake Blanchette, Brandon Kinard, Ben Harris, Drew Tucker, Joseph Stafford, Dan Washington, William Ward, Chad Smith and Scott Herrington. Manager: Jimmy Tucker; Coaches: Jerry Nichols and Jackie Tucker.

WOODVILLE HARDWOOD

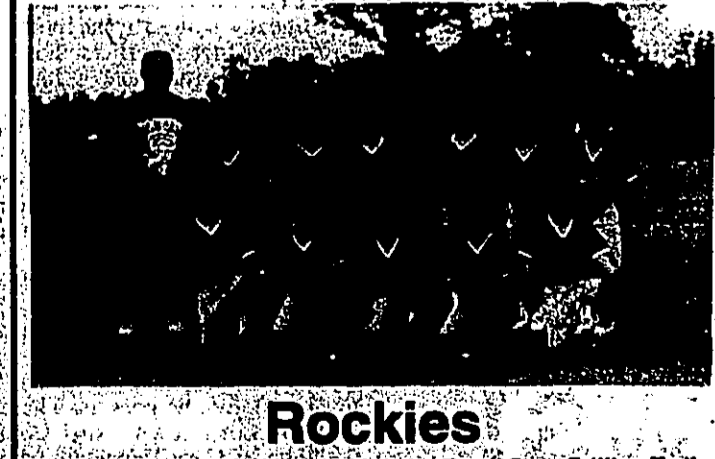

Rockies

Jordan Addison, P. J. Edwards, Nicholas Fort, Chris Callier, Emily Rogers, Justin Burns, Billy Joe Carter, Derek Hurdin, Ross Johnston, Marty Nash and Matt Wiggins. Sponsor: Shades Of Jade/Daniel Burns; Manager: Martin Nash; Coaches: Billy Wiggins and Daniel Burns; Sweetheart: Emily Rogers; Team Mom: Debbie Addison and Rhonda Johnson.

WOODVILLE HARDWOOD



White Sox

Brian Martin, T. J. Sturrock, Joshua Cruise, Billy Lewis, Brian Chatman, Clay Hensarling, Jay Clinton, Adam Grissom, John Christian, Bronson Grimes, Patrick Hadnot and Steven English. Manager: Phillip Martin; Coach: Tommy Hensarling.

G.W. LOGGING

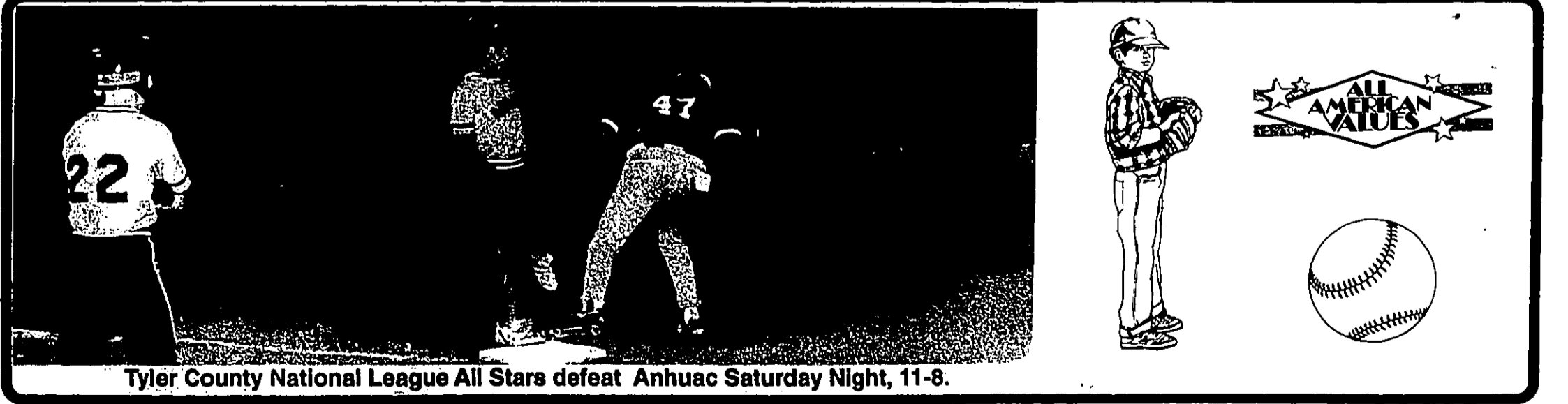

Tyler County National League All Stars defeat Anhuac Saturday Night, 11-8.

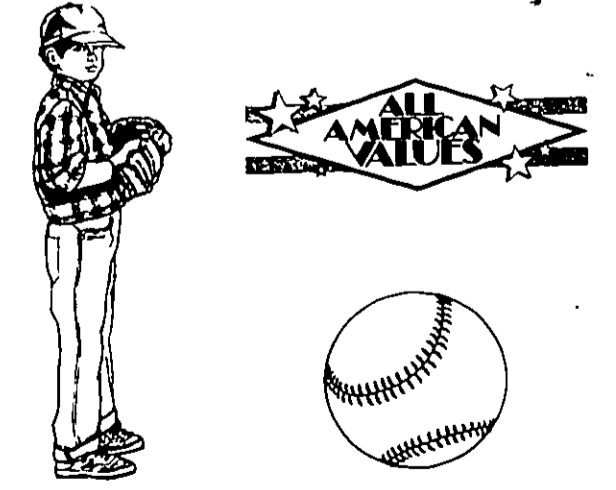

TYLER COUNTY GIRLS SOFTBALL SENIOR LEAGUE



Cowgirls

Grace Boykin, Michelle Parrish, Nicole Muve, Mary Garzaway, Christy Brown, Beth Wilson, Kimberly Broom, Kassi Strickland, Allison Cruise, Jennifer Tolbert, Justina Berryman, Stacie Hensarling, Eryn Byron and Laura Kenness. Sponsor: Rose Paint Center; Coaches: Bruce Strickland and Jimmy Cruise; Sweetheart: Curtis Jubiler.

WOODVILLE HARDWOOD



Rascals

Rita Hough, Melanie Hughlett, Rachael Harvey, Jamie Shepherd, Jennifer Maxwell, Christina Allison, Charla Davis, Kemea Allen, Anee Allen, Tracy Greer, Kirsten Babin, Cassandra Mitchell, Amanda Mitchell and Larshia Humphrey. Sponsor: Allison Chevrolet; Coaches: Cindy Hensarling and Avera Hough; Sweetheart: Ricky Fontenberry.

ALLISON CHEVROLET



Colmesneil Sr.

Chelanie Shults, Amanda Fowler, Candy Broom, Casey Snider, Alicia Fowler, Bridgette Jamail, Kaylee Toler, Rachel Thompson, Heather Flowers, Tiffany Parker, Crystal Pittman, Jennifer Reynolds and Sabrina Nelson. Sponsor: Allison Chevrolet; Coaches: Ricky Coker and Cecilia Reynolds; Sweetheart: Heather Flowers.

ALLISON CHEVROLET

TYLER COUNTY GIRLS SOFTBALL BIG LEAGUE

Girls Softball Final

T- Ball	W	L	Tie
Blazers	8	0	
Little Rascals	5	2	1
Mustangs	5	3	
Lady Jacks	1	5	2
Tornados	1	6	1
Little League	W	L	Tie
Red Babes	16	0	
C & C	13	3	
Cheetahs	12	4	
Marlins	9	7	
Blue Jays	8	8	
Yellow Jackets	2	13	1
Daisy Dukes	2	14	
Lady Bugs	1	14	1
Senior League	W	L	Tie
Rascals	9	5	
Cowgirls	9	5	
Colmesneil	3	11	
Big League	W	L	Tie
Rockettes	9	4	
Lady Jacks	8	5	



Rockettes

Amy Sanford, Misty Haynes, Olivia Sirban, Doretta Fortenberry, Rachel McKinney, Noelle Berryman, Jessica Browning, Jennifer Abbott, Krystal Davis, Angela Heath, Jennifer Pittman and Tara Horn. Sponsor: Knapp Ford; Coaches: David Davis and Ronnie Ford; Sweetheart: Krystal Davis.

KNAPP FORD



Lady Jacks

Karie Hubert, Stacy Whitworth, Laura Lowe, Adrienne Bryan, Jennifer Bryan, Elizabeth Ewings, Wendy Whitworth, Tina Collins, Amber Brown and Brandi Williams. Sponsor: Champion; Coaches: Bronson Williams and James Ewings; Sweetheart: Adrienne Bryan.

CHAMPION

SUPPORT ALL TYLER COUNTY BASEBALL AND SOFTBALL TEAMS!

Thanks To You Over 240 Girls Got to Play Softball This Season In Tyler County!

Farmers Feed
 Donald DuBose
 James Young
 Mike Stacey
 John Craine-
 Keller Industries
 E & L Lumber Co.
 James Collier
 Boykin Lumber
 Rose Paint Center
 McCoy Tree Service
 Knapp Ford Sales, Inc.
 Allison Chevrolet
 Pete Barnes
 Champion International
 Woodville Lions Club

Tyler County Sheriff's
 Activity League
 Davis Davis
 After Affects
 Arthur Bean
 A to Z Auto Parts
 Woodville Electric
 Woodville Veterinary Clinic
 Mr and Mrs Irvin
 Monk Investigation
 Donnie Poindexter
 Ladies Auxiliary
 McWaters Trucking
 Louisiana Pacific
 Walter Umphrey
 1st State Bank-Colmesneil

Wal-Mart

1121 S. Magnolia, Woodville, Texas. HOURS: Mon.-Sat: 8 am-9 pm, Sun. 10-6



WAL-MART'S ADVERTISED MERCHANDISE POLICY... is our intention to have every advertised item in stock. However, if due to any unforeseen reason, an advertised item is not available for purchase, Wal-Mart will issue a Rain Check on request, for the merchandise to be purchased at the sale price whenever available, or will sell you a similar item at a comparable reduction in price. We reserve the right to limit quantities. Limitations void in New Mexico.



TYLER COUNTY GIRLS SOFTBALL T-BALL



Blazers

Kyndal Howard, Missy Waters, Melissa Cheney, Patricia Sutton, Suzanna Sutton, JaVonna Pittman, LaShawna Butler, Selena Baird, Jessica Baird, Michelle Reynolds, Melissa Reynolds, Marilyn Gibbs, Ashley Adaway and Alyson Rainey. Sponsor: Allison Chevrolet; Coaches: Ernestine Waters and Kandl Howard; Sweetheart: Melissa Cheney.

ALLISON CHEVROLET



Tornados

Keri Denmark, Mary Dennis, Whitney F. nsarling, Ashley Irvin, Jessica McCoy, Crystal McNeal, Sarah Odum, Emily Stankey, Krystle Vann, Heather Allen-Worthy and Alysha Yancey. Sponsor: Mr. & Mrs. Irvin, Donnie Poindexter, Monk Investigation; Coach: Amy McCoy; Sweetheart: Ashley Irvin.

FD18 CITIZENS STATE BANK



Mustangs

Jessica Ratcliff, Blaire Blanchette, Laura Babin, Brittany Bean, Danielle Bean, Erin Rainey, Brandi Laine, Sica Simpson, Robin Dostle, Autumn Hall, Danielle Skinner, Amber Rainey and Jenna Rainey. Sponsor: Lady's Auxiliary; Coaches: Lyle Rainey and Debbie Skinner; Sweetheart: Erin Rainey.

INDIAN RESERVATION



Lady Jacks

Marie Clowers, Jennifer Dunkin, Candice Erwin, Hilary Graham, Tamara Herrington, Tracy Laxon, Shelly Lay, Tanyan Maxwell, Chelsea Montzigo, Carmen Pickett, Summer Tullos and Ashley Worthy. Sponsor: McWaters Trucking; Coach: Teresa Dunkin; Sweetheart: Chelsea Montzigo.

MAGNOLIA APPLIANCE

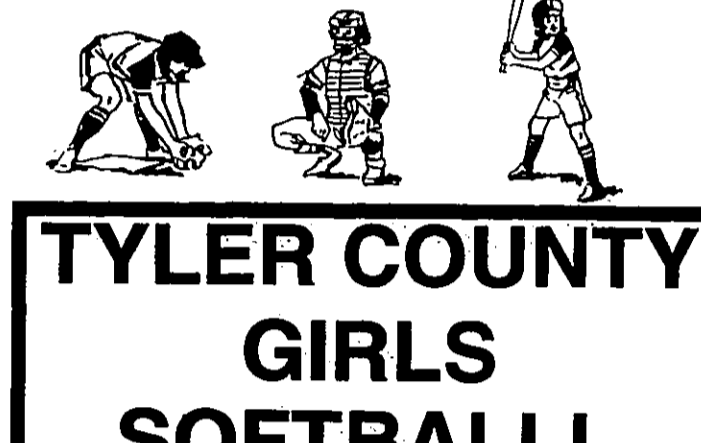

TYLER COUNTY GIRLS SOFTBALL LITTLE LEAGUE

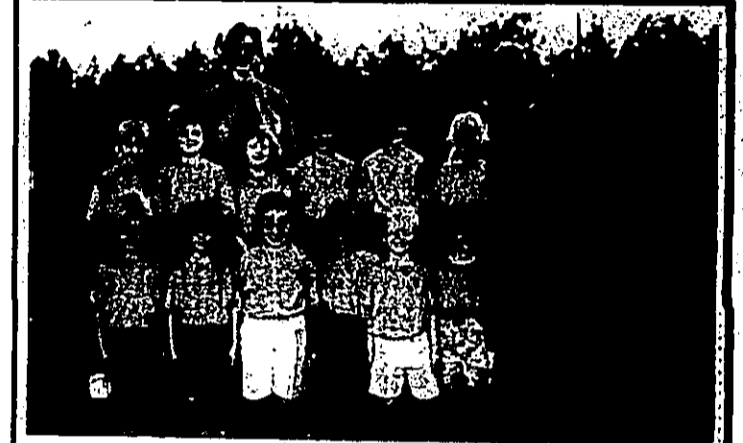

Little Rascals

Corby Weyler, Tara Burns, Cassie Ogden, Ashley Downs, Ashly Smith, Brandi Foxworth, Leslie Rogers, Jessica Williams, Nicki McCallum, Brandi Wise, Amber Wigley, Autumn Caldwell, Heather Morris, Laksha Barclay, Courtney Bainbridge and Leah Elliott. Sponsor: After Affects; Coaches: Holly Weyler and Sherlyon Burns; Sweetheart: Ashley Downs.

AFTER AFFECTS



Lady Bugs

Carla Daniel, Renee Barnes, Michelle Barnes, Monica Woodrone, Stephanie Nicolsland, Jana Hubert, Emily Payne, Margie McCarty, Elizabeth Pounds and Jennifer Whitehead. Sponsor: Champion; Coaches: Carolyn Daniel and Deby Barnes; Sweetheart: Elizabeth Pounds.

CHAMPION

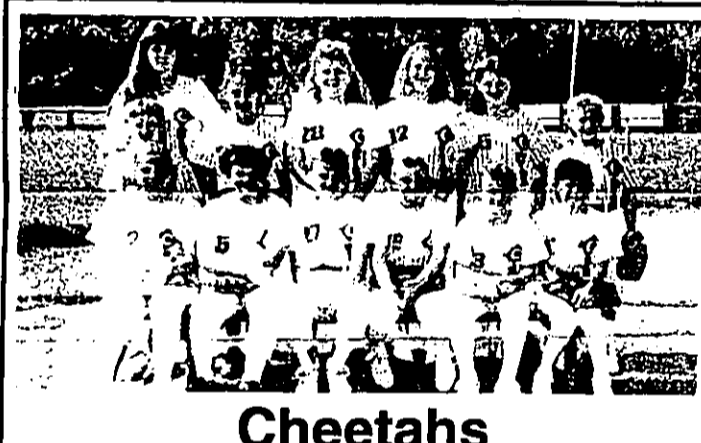

Cheetahs

Ashley Flowers, Cassie Flowers, Courtney Flowers, Kimberly Lucas, Jessica Standley, Jessalyn Davis, Josi Rawls, Wendy Franks, Krystal Cook, Stephanie Parker, Christine Parker and Becki Loflin. Sponsor: Champion; Coaches: Sue Flowers and Cary Lucas; Sweetheart: Josie Rawls.

CHAMPION



C & C Allstars

Katrina Corn, Ashley Tibbets, Laura Wooten, Sharon Crawford, Samantha Potts, Michelle Meadows, Amy Dubose, Michelle Johnson, Ashlee Bainbridge, Brandi Wood and Jessica Sisson. Sponsor: E & L Lumber; Coaches: Kathy Corn and Peggy Walters; Sweetheart: Katrina Corn.

E&L LUMBER COMPANY



Daisy Dukes

Annie Coke, Bridgette Corn, Liz Mosby, Hope Murphy, Jamie Willis, Megan Young, Jessica Spiller, Rebecca Dister, Heather McCough, Chee McCough and Anna Roundtree. Sponsor: Louisiana Pacific; Coaches: Dewey Coke and Billie Corn; Sweetheart: Bridgette Corn.

BOYKIN LUMBER COMPANY



Marlins

Michelle Barlow, Ashley Millam, Dianne Reid, Janay Wigley, Amber Chandler, Kourtney Davis, Ashley Yancey, Joany Reid, Candace Lambert, Erin Dennis, Chantell Montzigo, Linda Hernandez and Tiffany McCulley. Sponsor: A-Z Auto Parts; Coaches: Otis Wigley and Ronnie Millam; Sweetheart: Chantell Montzigo.

KATRINA'S STYLING SALON



Terminators

Samantha Ponder, Amber Sanford, Jennifer Rucks, Telisha Wade, Kasey Broom, Hollie Broom, Courtney Broom, Audrea Dabill, Jennifer Shelton, Diana Horn, Tasha Lee and April Tullos. Sponsor: Woodville Electric; Coaches: Virginia Ponder and Berunda Broom; Sweetheart and League Queen: Samantha Ponder.

1ST NATIONAL BANK



Yellow Jackets

Heather Nesbitt, Caitrina Weems, Lyssa Dennard, Krystle Czupla, Jenifer Allen, Jennifer Broom, Tommie Foley, Ashley Gilchrist, Amy Carter, Markeshia Paul, Stephanie Nix, Anita Helton and Latoya Hadnot. Sponsor: Walter Umphrey; Coaches: Ron Denmark and Preston Broom; Sweetheart: Lyssa Dennard.

SURETY BANK



Red Babes

Kaci Andrus, Charla Bendy, Miranda Cheney, Brittanie Crews, Ashley Danuser, Kelly Gallagher, Kristina Gallagher, Holly Robertson, Tishannah Ross, Bridgette Snider, Melissa Tompkins, Michelle Williams and Sonya Daniels. Sponsor: First State Bank - Colmesneil; Coach: Sharon Andrus; Sweetheart: Kelly Gallagher.

1ST STATE BANK, COLMESNEIL



Blue Jays

Misty Lott, Jessica Maxwell, Bridget Dattilo, Brandy O'Neil, Amy Broom, Jessica Smith, Leah Hargrave, April Haynes, Angela Youngblood, Lea Ann Hensarling, Amanda Pancher, Karen McCluskey and Amber Stafford. Sponsor: Woodville Veterinary Clinic; Coaches: Gordon McCluskey and Phillip Broom; Sweetheart: Brandy O'Neil.

YVONNE'S ANTIQUES

Thanks To You Over 700 Kids Got to Play Baseball This Season In Tyler County

Walter and Sheila Umphrey-\$45,000-
Lights on two new fields
T.L.L.Temple Foundation-\$30,000-Grant
Louisiana Pacific-\$10,000-
Boards and Wood for Stands
E & L Lumber Co.-\$3,000-Lights
Few Ready Mix-Concrete
Ron Poindexter-Metal for
dugouts and stands
Lindsey Whisenant-dugouts
Allan Bell-fence material
Troy Blakeney-\$2,500 fencing
Ken Baily, Attorney- Mower
Don Shaw-City of Woodville
Commissioners Court of Tyler County
Doctors and Physicians of Tyler County
-\$900 -Trophies

Woodville Inn
Rose Paint Center
Charlie Cox-Supervisor-Warren
Elton Hightower-Supervisor-Colmesneil
Marvin Mott-Supervisor-Spürger
Jim Whitworth-Supervisor-Chester
Dr. Clint O'Neal-Supervisor-

T-Ball & Pitchball
Jimmie Tucker-Supervisor-Minor
Tommy Weaver-Supervisor-
Major and Senior League
Richard Guillory-Minor League Umpires
Martin Riley-Major League Umpires
Pat Cherry and Luke Satterwhite-
Senior League and
Big League Umpires

Phillip Martin-Electric Lighting
Royce Best-Electric Lighting
Boykin Lumber
Phil Hart-Welding
Alton Tucker

Jacques Blanchette- Announcer
Patti Tucker-Scorekeeper
Sandy Ferguson-Queen's Race
Connie's Flower Shop-Flowers
John Pat White-Electronics
Karen Ivy-Concession Stand
McDonald's
Dairy Queen
Subway
Texas Metals
KVLL

THE TYLER COUNTY BOOSTER
Bob Boykin Photography

TEAM SPONSORS:

G.W. Logging: Minor White Sox
Crown Cable: Phillies T-Ball
RPM: Pirates T-Ball
Community Bank: Astros-Major
Davis Food, Col.: Braves-Major
Knapp Ford: Astros-T-Ball
East Texas Insurance: Reds-T-Ball
J & S Drugs: Padres-Major
Lindsey Whisenant, Attorney:
Mariners-Minor
Spindeltop Street Rods: Rockies-T-Ball
Satterwhite Pharmacy: Blue Jays-T-Ball
Hensarling Mobil: Mets-Major
Davis Food, Warren: Rockies-Major
Hatton Logging: Pirates-Major
Davis Grocery: Braves-Minor
Dr. Clint O'Neal: Tigers-T-Ball
A & M Motor Company: Yanks-Major
Chester Lions: Rangers-Minor
Bob's Photo: Red Sox-Minor
State Farm Insurance: Mets -T-Ball
Citizen's State Bank: Tigers-Major
1st State Bank-Colmesneil: Cards-Major
Dr. Clint O'Neal: Tigers-T-Ball
Surety Bank: Chester-Rangers-T-Ball
Robert Woods, Attorney: Mets-Minor
V.F.W. Post 2033: Giants- Minor
Jarrott's Pharmacy: Royals-Pitchball
G & W. Logging: Cards-Pitchball
Keller Industries: White Sox-Major
Jasper Mack Truck Sales: Cards-Minor
Texas Metals: Orioles- Pitchball
Surety Bank-Chester: Cards-Major

SENIOR LEAGUE SPONSORS:

Woodville Rotary Club
Woodville Lions Club
Jerry Rains
Satterwhite Pharmacy
Robert Woods, Attorney

201 Cheriton,
Woodville,
Texas

Brookshire Bros.

OPEN SUNDAY
8-5
MONDAY THRU
SATURDAY 7-9

LOWER FOOD PRICES

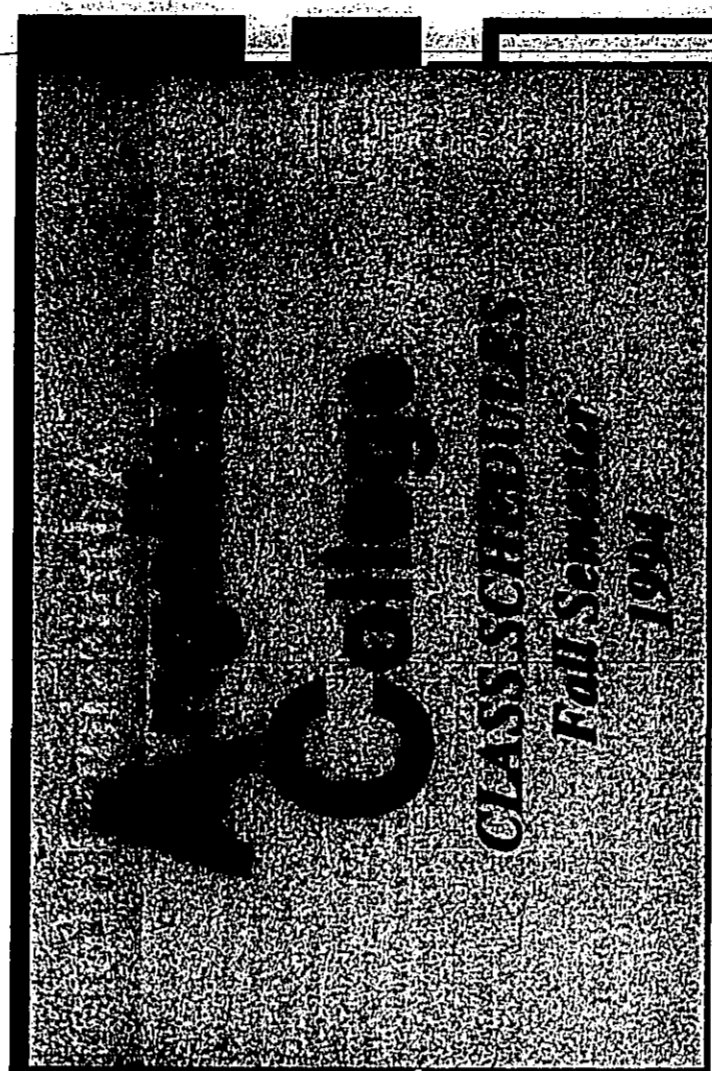
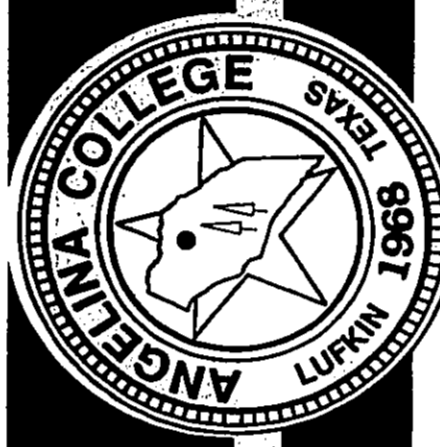

How to Register

New Students: Submit an application to the Admissions Office. Apply for financial aid—Student Center, Room 208. Take placement tests to assess your basic academic skills—Student Center, Room 208.

Returning Students: Get a permit to register—Admissions Office. Have your academic basic skills tested if necessary—Some returning students must take placement tests on the T-ASP test.

All Students: Continue registration by visiting a counselor or faculty adviser—Student Services Student Center, Room 208 or advisor's office. All students must see a counselor or faculty adviser each semester before signing up for classes. Register for classes. Pay tuition and fees—Business Offices. Gather Window—Administration Building. Registration is not complete until tuition and fees are paid. Start Fall Classes—Classes begin Aug. 29.

Accreditation

Angelina College is accredited by the Texas Higher Education Coordinating Board, the Texas Education Agency and is accredited by the Commission on Colleges of the Southern Association of Colleges and Schools to award the Association of Arts, Association of Science and Associate of Applied Science degrees. Certifications of completion, AC holds membership in the Association of Texas Colleges and Universities and the American Association of Community Colleges.

Angelina College admits students without regard for race, color, sex, religion, age or national origin. Inquiries concerning sex equity or disability should be directed to Dr. Patricia McKenka at (409) 639-1301.

Important Dates To Remember

July 18-21	Early Fall Registration
July 25	Fall registration permits available in Admissions Office
Aug. 2 or 11	ASSET Testing for all Fall Semester orientation students
Aug. 4	Last day of early Fall registration fee payment. Failure to pay fees by deadline will result in cancellation of registration.
Aug. 4 or 9, 16, or 18	Freshman orientation, advisement and registration
Aug. 15, 17	Off-Campus registration for Fall Semester
Aug. 21	Dormitory Check-in 1 p.m. - 4 p.m.
Aug. 22	General Faculty Meeting
Aug. 23	ASSET Testing 5-30 p.m.
Aug. 24	Fall Semester registration, 8:30 a.m.-8:30 p.m.; Permit only
Aug. 25	Fall Semester registration, 8:30 a.m.-6:30 p.m.; Permit only
Aug. 26	First day of late registration
Aug. 30	Registration ends
Aug. 31	ASSET Testing, 8:30 a.m.
Aug. 31	Last day of schedule changes
Sept. 5	Labor Day Holiday
Sept. 14	Twelfth Class Day
Sept. 26	Last day to withdraw with a partial refund
Sept. 26	Last day to withdraw with a grade of "W"
Oct. 3	Time to file for December graduation
Oct. 21	Mid-semester
Nov. 23	Thanksgiving Holidays
Nov. 18	Last day to register for December graduation
Nov. 28	Early Registration for Spring 1995 begins
Nov. 28	Last day to withdraw from or drop classes
Dec. 9-15	Final Exams

TECHNICAL-VOCATIONAL DIVISION

Course No.	Lab	Description	Fee	Time	Day	Instructor	Room
1610.01	Lab Tech I	Lab Tech I	\$15	10:00-12:00	W	Hobbs	TBA
1620.01	Auto Tech I	Auto Tech I	\$15	10:00-12:00	W	Hobbs	TBA
1630.01	Auto Tech II	Auto Tech II	\$15	10:00-12:00	W	Hobbs	TBA
1640.01	Auto Tech II Lab	Auto Tech II Lab	\$15	10:00-12:00	W	Hobbs	TBA
2110.01	Alcohol Dependence	Alcohol Dependence	\$0	8:00-9:00	W	Morgan	B201
2200.01	Dual Diagnosis	Dual Diagnosis	\$0	8:00-9:00	W	Morgan	B201
2210.01	Substance Abuse	Substance Abuse	\$0	8:00-9:00	W	Morgan	B201
2220.01	Family Code	Family Code	\$0	8:00-9:00	W	Morgan	B201
2230.01	Substance Abuse	Substance Abuse	\$0	8:00-9:00	W	Morgan	B201
2240.01	Family Code	Family Code	\$0	8:00-9:00	W	Morgan	B201
2250.01	Substance Abuse	Substance Abuse	\$0	8:00-9:00	W	Morgan	B201
2260.01	Family Code	Family Code	\$0	8:00-9:00	W	Morgan	B201
2270.01	Substance Abuse	Substance Abuse	\$0	8:00-9:00	W	Morgan	B201
2280.01	Family Code	Family Code	\$0	8:00-9:00	W	Morgan	B201
2290.01	Substance Abuse	Substance Abuse	\$0	8:00-9:00	W	Morgan	B201
2300.01	Family Code	Family Code	\$0	8:00-9:00	W	Morgan	B201
2310.01	Substance Abuse	Substance Abuse	\$0	8:00-9:00	W	Morgan	B201
2320.01	Family Code	Family Code	\$0	8:00-9:00	W	Morgan	B201
2330.01	Substance Abuse	Substance Abuse	\$0	8:00-9:00	W	Morgan	B201
2340.01	Family Code	Family Code	\$0	8:00-9:00	W	Morgan	B201
2350.01	Substance Abuse	Substance Abuse	\$0	8:00-9:00	W	Morgan	B201
2360.01	Family Code	Family Code	\$0	8:00-9:00	W	Morgan	B201
2370.01	Substance Abuse	Substance Abuse	\$0	8:00-9:00	W	Morgan	B201
2380.01	Family Code	Family Code	\$0	8:00-9:00	W	Morgan	B201
2390.01	Substance Abuse	Substance Abuse	\$0	8:00-9:00	W	Morgan	B201
2400.01	Family Code	Family Code	\$0	8:00-9:00	W	Morgan	B201
2410.01	Substance Abuse	Substance Abuse	\$0	8:00-9:00	W	Morgan	B201
2420.01	Family Code	Family Code	\$0	8:00-9:00	W	Morgan	B201
2430.01	Substance Abuse	Substance Abuse	\$0	8:00-9:00	W	Morgan	B201
2440.01	Family Code	Family Code	\$0	8:00-9:00	W	Morgan	B201
2450.01	Substance Abuse	Substance Abuse	\$0	8:00-9:00	W	Morgan	B201
2460.01	Family Code	Family Code	\$0	8:00-9:00	W	Morgan	B201
2470.01	Substance Abuse	Substance Abuse	\$0	8:00-9:00	W	Morgan	B201
2480.01	Family Code	Family Code	\$0	8:00-9:00	W	Morgan	B201
2490.01	Substance Abuse	Substance Abuse	\$0	8:00-9:00	W	Morgan	B201
2500.01	Family Code	Family Code	\$0	8:00-9:00	W	Morgan	B201

OFF-CAMPUS TEACHING CENTERS

Course No.	Lab	Description	Fee	Time	Day	Instructor	Room
1301.01	Lab	Introduction to Business	\$15	8:00-9:00	T	Brewer	TBA
1302.01	Lab	Introduction to Business	\$15	8:00-9:00	T	Brewer	TBA
1303.01	Lab	Introduction to Business	\$15	8:00-9:00	T	Brewer	TBA
1304.01	Lab	Introduction to Business	\$15	8:00-9:00	T	Brewer	TBA
1305.01	Lab	Introduction to Business	\$15	8:00-9:00	T	Brewer	TBA
1306.01	Lab	Introduction to Business	\$15	8:00-9:00	T	Brewer	TBA
1307.01	Lab	Introduction to Business	\$15	8:00-9:00	T	Brewer	TBA
1308.01	Lab	Introduction to Business	\$15	8:00-9:00	T	Brewer	TBA
1309.01	Lab	Introduction to Business	\$15	8:00-9:00	T	Brewer	TBA
1310.01	Lab	Introduction to Business	\$15	8:00-9:00	T	Brewer	TBA
1311.01	Lab	Introduction to Business	\$15	8:00-9:00	T	Brewer	TBA
1312.01	Lab	Introduction to Business	\$15	8:00-9:00	T	Brewer	TBA
1313.01	Lab	Introduction to Business	\$15	8:00-9:00	T	Brewer	TBA
1314.01	Lab	Introduction to Business	\$15	8:00-9:00	T	Brewer	TBA
1315.01	Lab	Introduction to Business	\$15	8:00-9:00	T	Brewer	TBA
1316.01	Lab	Introduction to Business	\$15	8:00-9:00	T	Brewer	TBA
1317.01	Lab	Introduction to Business	\$15	8:00-9:00	T	Brewer	TBA
1318.01	Lab	Introduction to Business	\$15	8:00-9:00	T	Brewer	TBA
1319.01	Lab	Introduction to Business	\$15	8:00-9:00	T	Brewer	TBA
1320.01	Lab	Introduction to Business	\$15	8:00-9:00	T	Brewer	TBA

Call the Admissions Office:
M-R 8 a.m. - 5 p.m.
(409) 633-5212

ANGELINA COLLEGE
1. Full legal name
2. How long have you lived in Angelina County? Circle One: Yes No
3. Semester you plan to enter Angelina College: Circle One: Fall Spring Summer I Summer II
4. Do you ever plan to go back to school in Texas? Circle One: Yes No
5. Have you ever been suspended from any college or university? Circle One: Yes No
6. If you are currently attending a college or university, please provide the name, address, and phone number of the institution.

ANGELINA COLLEGE
7. Name of parent or guardian (if applicable)
8. Address of parent or guardian
9. City, State, Zip
10. Date of birth
11. Social Security Number
12. Telephone number (if available)

ANGELINA COLLEGE
13. How long have you lived in Angelina County?
14. Do you ever plan to go back to school in Texas?
15. Have you ever been suspended from any college or university?
16. If you are currently attending a college or university, please provide the name, address, and phone number of the institution.

ANGELINA COLLEGE
17. Name of parent or guardian
18. Address of parent or guardian
19. City, State, Zip
20. Date of birth
21. Social Security Number
22. Telephone number (if available)

SCIENCE-MATHEMATICS DIVISION

Course No.	Section	Course Description	Prerequisites	Time	By	Index	Room
101	101	College Algebra	Math 100	8:00-9:00 AM	Dubey	101	101
102	102	Calculus I	Math 101	8:00-9:00 AM	Dubey	102	102
103	103	Calculus II	Math 102	8:00-9:00 AM	Dubey	103	103
104	104	Calculus III	Math 103	8:00-9:00 AM	Dubey	104	104
105	105	Differential Equations	Math 102	8:00-9:00 AM	Dubey	105	105
106	106	Statistics	Math 100	8:00-9:00 AM	Dubey	106	106
107	107	Probability	Math 100	8:00-9:00 AM	Dubey	107	107
108	108	Geometry	Math 100	8:00-9:00 AM	Dubey	108	108
109	109	Trigonometry	Math 100	8:00-9:00 AM	Dubey	109	109
110	110	Mathematical Proofs	Math 100	8:00-9:00 AM	Dubey	110	110

Course No.	Section	Course Description	Prerequisites	Time	By	Index	Room
111	111	Computer Applications	None	8:00-9:00 AM	Dubey	111	111
112	112	Discrete Math	Math 100	8:00-9:00 AM	Dubey	112	112
113	113	Number Theory	Math 100	8:00-9:00 AM	Dubey	113	113
114	114	Group Theory	Math 100	8:00-9:00 AM	Dubey	114	114
115	115	Ring Theory	Math 100	8:00-9:00 AM	Dubey	115	115
116	116	Field Theory	Math 100	8:00-9:00 AM	Dubey	116	116
117	117	Mathematical Induction	Math 100	8:00-9:00 AM	Dubey	117	117
118	118	Mathematical Logic	Math 100	8:00-9:00 AM	Dubey	118	118
119	119	Mathematical Language	Math 100	8:00-9:00 AM	Dubey	119	119
120	120	Mathematical Thought	Math 100	8:00-9:00 AM	Dubey	120	120

Admission Information

ANGELINA COLLEGE
1. Full legal name
2. How long have you lived in Angelina County?
3. Semester you plan to enter Angelina College?
4. Do you ever plan to go back to school in Texas?

ANGELINA COLLEGE
5. Name of parent or guardian
6. Address of parent or guardian
7. City, State, Zip
8. Date of birth
9. Social Security Number
10. Telephone number (if available)

Call the Admissions Office:
M-R 8 a.m. - 5 p.m.
(409) 633-5212

ANGELINA COLLEGE
1. Full legal name
2. How long have you lived in Angelina County?
3. Semester you plan to enter Angelina College?
4. Do you ever plan to go back to school in Texas?

ANGELINA COLLEGE
5. Name of parent or guardian
6. Address of parent or guardian
7. City, State, Zip
8. Date of birth
9. Social Security Number
10. Telephone number (if available)

ANGELINA COLLEGE
11. How long have you lived in Angelina County?
12. Do you ever plan to go back to school in Texas?
13. Have you ever been suspended from any college or university?
14. If you are currently attending a college or university, please provide the name, address, and phone number of the institution.

ANGELINA COLLEGE
15. Name of parent or guardian
16. Address of parent or guardian
17. City, State, Zip
18. Date of birth
19. Social Security Number
20. Telephone number (if available)